

Appendix J

Statement of heritage impact



Transport
Roads & Maritime
Services

BARHAM-KOONDROOK BRIDGE

Capacity Upgrade

Statement of Heritage Impact

November 2014

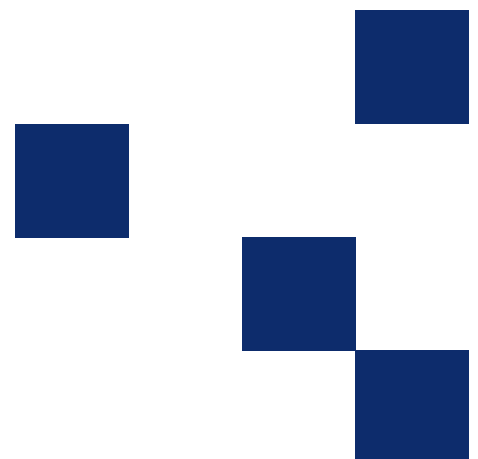

About this release

Title	Barham Bridge capacity upgrade Statement of Heritage Impact
--------------	---

Approval and authorisation		Name
Prepared by	Environmental Officer (Heritage)	Ian Berger
Approved by	Senior Environmental Specialist (Heritage)	Denis Gojak

Location	File name
G:\ENVIRNMNT\Policy\Heritage\Project Advice\Barham Bridge SOHI.doc	Barham Bridge SOHI.doc

Document status	Date
Final	November 2014

Version	Date	Revision Description
Final	November 2014	

Prepared by
 Environment Branch
 Roads and Maritime Services
 Level 17, 101 Miller Street
 North Sydney, NSW 2060
 T 02 8588 5726

Contents

1	Introduction	4
2	Historical overview and recent background.....	7
3	Heritage significance.....	19
4	Bridge components.....	23
5	Proposed works	33
6	Statement of Heritage Impact	44
7	Conclusion and recommendations.....	46
8	References.....	48

Appendix A: *Barham Koondrook Bridge restoration works community update, December 2013*

Appendix B: NSW State Heritage Register listing

Appendix C: RMS Section 170 listing

Appendix D: Victorian Heritage Register listing

Appendix E: Plans of proposed works

1 INTRODUCTION

1.1 Proposal Background

The NSW Roads and Maritime Services (RMS) propose to undertake modifications to Barham- Koondrook Bridge in order to increase its load carrying capacity.

Barham- Koondrook Bridge (hereafter referred to as Barham Bridge) is to be upgraded and retained as part of the strategic document, the *Timber Truss Road Bridges – a Strategic Approach to Conservation* (the Strategy) (RTA 2011), which was endorsed by the Heritage Council of NSW on 13 August 2012. The Strategy was prepared in order to represent a balance of transport needs and heritage conservation for its listed timber truss bridges. The Strategy identifies that of the 48 timber truss bridges managed by the RMS, 26 would be retained and 22 would be progressively replaced over the next 15 years.

Prior to the development of the Strategy, all timber truss bridges were upgraded or bypassed on a case-by-case basis. The endorsed Strategy (2012) provides RMS asset managers planning certainty by identifying those bridges to be progressively removed over the next 15 years and those which will be maintained and upgraded as part of the significant heritage of NSW for future generations to appreciate.

This SoHI is required by the RMS as part of the consent conditions, as the proposed works directly impact on Barham Bridge, which is listed as a heritage item on the RMS Heritage & Conservation Register (under s170 of the NSW Heritage Act), the NSW State Heritage Register and the Victorian Heritage Register. The bridge is also listed as a local heritage item with the Wakool Shire Council.

The SoHI assesses aspects of the heritage significance of the bridge, and determines the significance of the impact on the heritage item, and as a representative of its type in NSW. The assessment follows the guidelines set out by the NSW Heritage Branch (Office of Environment and Heritage) publication *Statements of Heritage Impact* and the principles of the Australia ICOMOS *Burra Charter*. The Charter sets the standard of practice for providing advice or making decisions about, or undertaking works at places of heritage or cultural significance, including owners, managers and custodians (ICOMOS 1999). All Australian states have adopted the Charter as the basis for the conservation assessment and management of heritage places in Australia.

1.2 Location

Barham Bridge (aka Barham-Koondrook Bridge) is located over the Murray River within the Wakool Shire Council local government area. The location of the Bridge is shown in **figures 1 and 2**.

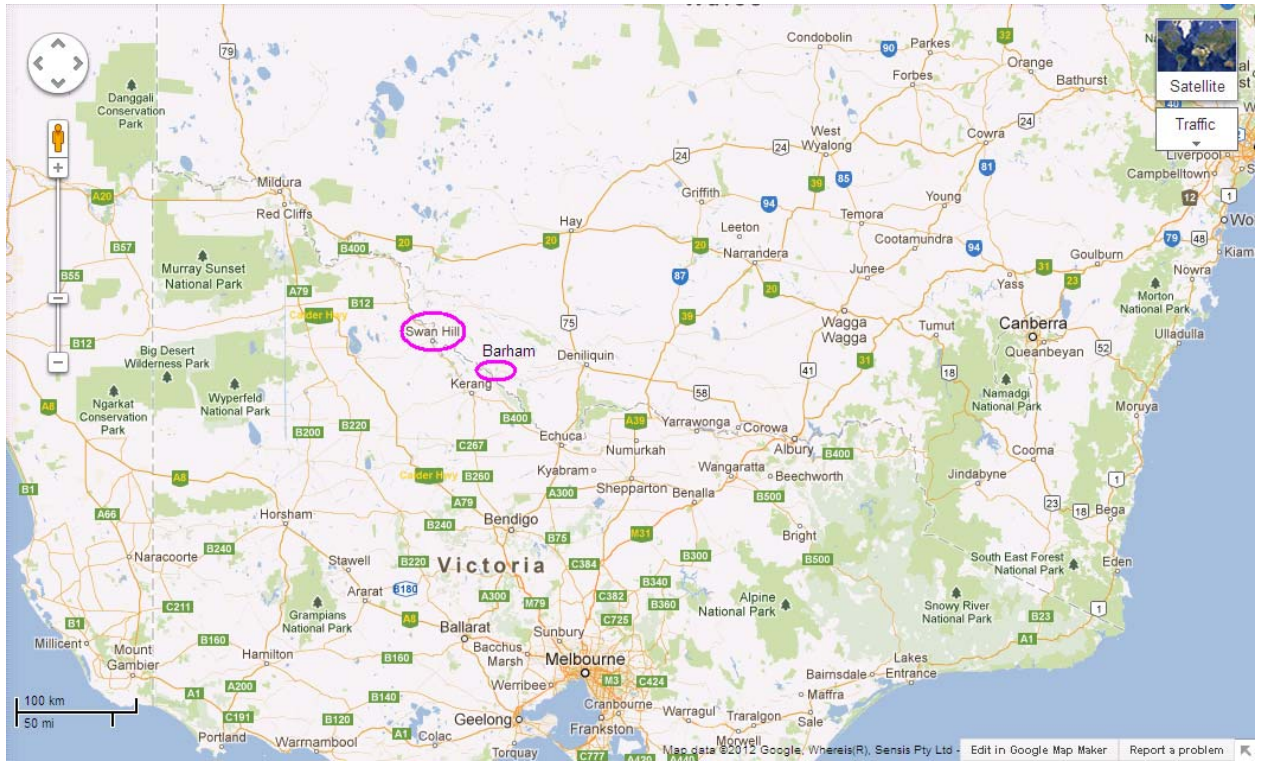

Figure 1: Location of Barham Bridge (circled) in relation to the nearby Swan Hill Bridge which is another timber truss and lift span bridge (Source: Google Maps).



Figure 2: Location of Barham Bridge (Map extract courtesy of the NSW Surveyor General's Department).

1.3 Report structure

This report:

- Outlines the background of the current study/proposal (Section 1).
- Provides a contextual framework in terms of an historical overview of the area (Section 2).
- Discusses issues such as statutory heritage listings and legislative requirements (Section 3).
- Identifies and describes the present physical overview of the heritage item (Section 4).
- Provides a description and evaluates the significance of affected items (Section 5).
- Provides a description of the proposed works (Section 6).
- Assesses the potential impacts from the proposal (Section 7).

1.4 Approach

The approach to the SoHI has been to determine factors contributing to the heritage significance of the site and assess the significance of the impact of the proposed works on the intrinsic heritage values of the site. The assessment has been prepared in accordance with the NSW Heritage Branch guideline *Statements of Heritage Impact* and the particular Heritage Provisions of Wakool Shire Council were considered.

The report specifically includes the following:

- Review of existing heritage assessments for the heritage item.
- A review of the Timber Truss Bridge Conservation Strategy: Submissions Report and Revised Conservation Strategy (RMS 2012b).
- Searches of Commonwealth, national and state heritage databases. This has included the National Heritage List and the NSW Heritage Branch State Heritage Register.
- Search of the Wakool Shire Council Local Environmental Plan (LEP) 2013.
- Search of the RMS Section 170 Heritage and Conservation Register (S170).
- Search of the NSW State Heritage Register (SHR)
- Search of the Victorian Heritage Register (VHR)
- Review of all other relevant literature.
- A site inspection was carried out in order to determine the physical aspects of the site.
- Historical research to help determine the heritage significance of the item.
- Assessment of the heritage significance of the Barham Bridge, and determination of the impacts on these items and if they are acceptable.

The report has been prepared in accordance with the NSW Heritage Branch guidelines in addition to any further requirements that need to be considered in order to satisfy legislative and management obligations of the RMS. Recommendations are provided accordingly that would help to avoid, minimise or mitigate against impacts to the identified cultural heritage values of the heritage item.

2 HISTORICAL OVERVIEW AND RECENT BACKGROUND

Section 3.1 is summarised from the comprehensive study of the Relative Heritage Significance of All Timber Truss Road Bridges by MBK (1998). Section 3.2 is a historical background of the development of the Barham-Koondrook area and Section 3.3 is a physical description of the Bridge.

Sections 3.4 and 3.5 provide a summary of the Timber Truss Bridge Conservation Strategy: Submissions Report and Revised Conservation Strategy (RMS 2012b) in regards to the conservation of timber truss bridges across the state.

2.1 Timber truss bridges

Timber truss bridges were used extensively throughout the state from 1860 through to 1936 and five different truss types were developed over that period. Of the 407 timber truss road bridges originally constructed, most have been replaced with new structures on the same or similar alignments. The remaining bridges are heavily affected by modern road and traffic requirements which, in the longer term, will necessitate the substantial upgrading of these bridges or their replacement with a new bridge (RMS 2012b).

Prior to the bridges being built, river crossings were often dangerous in times of rain, which caused bulk freight movement to be prohibitively expensive for most agricultural and mining produce. Only the high priced wool clip of the time was able to carry the costs and inconvenience imposed by the generally inadequate river crossings that often existed prior to the trusses construction (RMS 2012a).

Timber truss bridges were preferred by the Public Works Department from the mid 19th to the early 20th century because they were relatively cheap to construct, and used mostly local materials. The financially troubled governments of the day applied pressure to the Public Works Department to produce as much road and bridge work for as little cost as possible, using local materials. This condition effectively prohibited the use of iron and steel, as these, prior to the construction of the steel works at Newcastle in the early 20th century, had to be imported from England (RMS 2012a).

In 1890, as the economic depression began to grip New South Wales, chief draftsman and engineer, Percy Allan, began to incorporate the proper engineering science of the structural behaviour of trusses, and use the reliable strength data of Australian hardwoods obtained from Professor Warren's testing program at Sydney University in order to reduce the costs of construction and maintenance.

When John A McDonald joined the Department in 1879 he was one of the first bridge design specialists and was to become Engineer for Bridges from 1889 to 1893. Almost immediately after joining the Department he set about designing a new timber truss bridge that would be easier to build and maintain and which could carry loads significantly greater than the OLD PWD designs, in order to provide some allowance for future increases in vehicle loads. The design has become known as the McDonald Truss, following Percy Allan's 1924 reference to the "McDonald style" truss.

In 1893 Allan introduced his new design based on the American Howe Truss. It was not however, a composite truss because only the verticals were iron rods while the bottom chord, despite being a tension member, was still all timber. The new truss featured a much simpler arrangement of triangulations and incorporated many improvements and innovations, derived from his design and practical experience that made this truss a more cost-effective structure than its predecessors (**figure 3**).

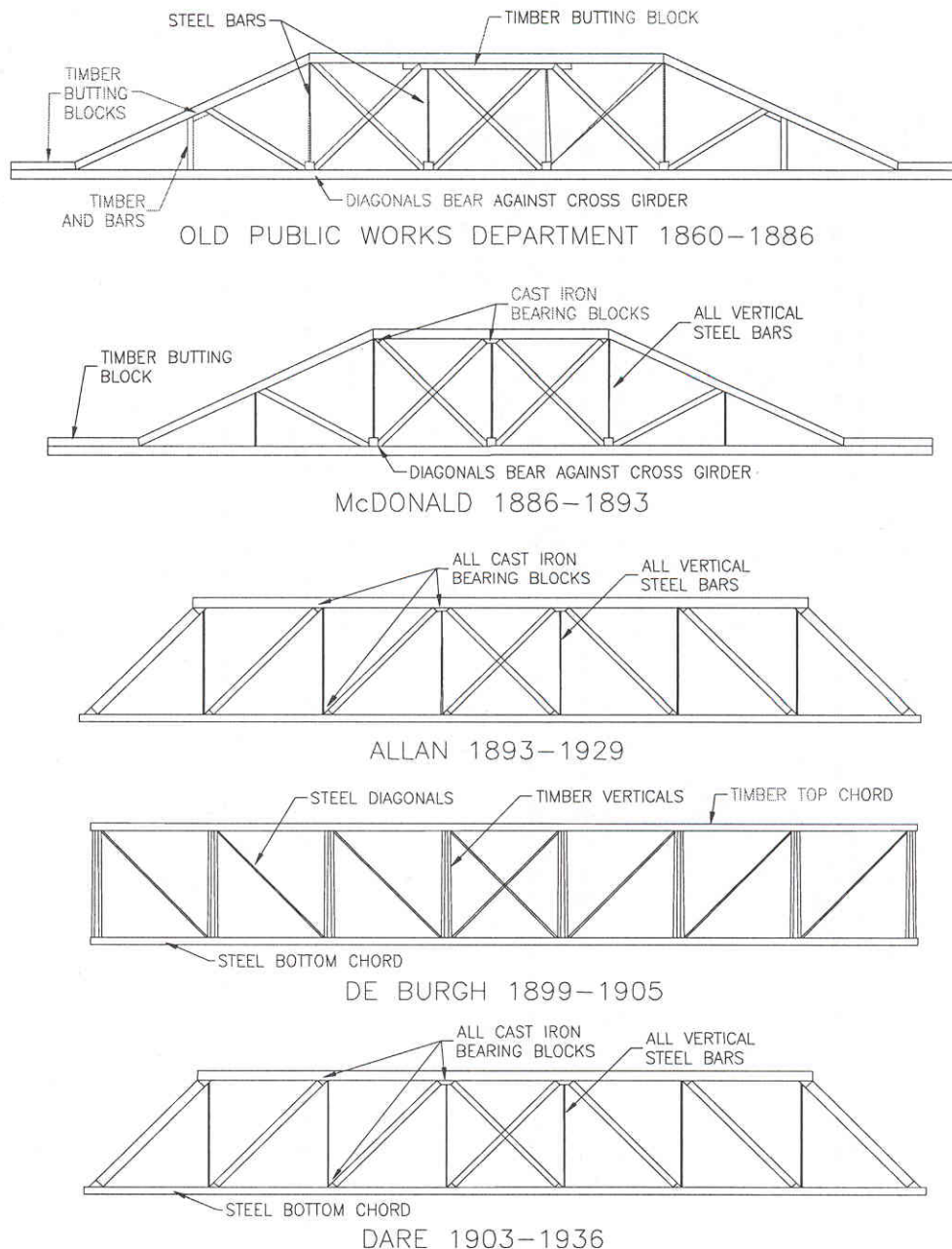

Figure 3: Comparison of the Old PWD Truss type and later Allan type, the lower two profiles are of the DeBurgh and Dare composite truss types (Source: DMR 1987).

By 1900 composite construction in America had been superseded by all-steel construction aided by a large increase in steel production in that country. In New

South Wales, however, conditions were quite different; steel was still an expensive import and so was in limited supply, and Australian timbers were superior to those in the USA both in strength and durability. Therefore, composite construction offered a compromise between all-timber and all-steel structures.

Two types of composite trusses were developed, the Pratt type by De Burgh in 1899, and the Howe type by Dare in 1903. Barham Bridge is a typical example of a De Burgh truss bridge.

2.2 History of the Barham-Koondrook area

The original settlement of Barham was typical of numerous other towns along the Murray River. Their development is attributed to being those sites where deep water allowed for river ports and also the regions where the river could be readily crossed (Painter 1993:13). Barham is the result of the first lease taken up in the western Wakool region. It was acquired by Edward Green, who named the property 'Barham' after his wife's family (Grant 190: 44).

Early settlers mainly consisted of pastoralists moving north from Victoria that primarily used the land for wool production and by 1850 most of the better river locations were occupied by these squatters (Heritage Office 1996: 149). Gold rushes during the 1850s shifted the land usage from wool production to beef cattle farming in order to meet the high demand from increased rural populations. However this shift was short lived and by the 1860s the wool industry dominated once again (HO 1996: 150). The dominance of wool continued until the 1890's when production of wheat increased dramatically. Finally in July 1893 a site for the township of Barham was surveyed and the first lots were sold (*Border Journal*, 1986: 39).

South of the Murray River, Koondrook became important for timber production and the port was heavily reliant on the local saw mill. It was commented that the 'streets were paved with sawdust' (Painter 1993: 69). Due to the increase in economic activity and local population the passage at Barham became an important link between southern parts of New South Wales and northern Victoria (Grant 1970: 15). Prior to the construction of the bridge a punt served as the only local crossing over the river (**Figure 4**). The punt was considered to be too inconvenient and unreliable due to its limited operating hours and old age, as it was previously used at Echuca for 30 years before being moved to Barham. Furthermore pastoralists would avoid the crossing as usage frequently decreased the value of stock due to "knocking about" (McConnell *et al* 1994: 11, 15).



Figure 4: Punt unloading cattle at Barham-Koondrook (Source: Grant 1970).

The lobbying for a bridge at Barham commenced in the 1890s and in June 1900 the PWD engineer E. M. De Burgh took evidence at Kerang and Koondrook in reference to “the matter” (McConnell et al 1994: 11). It was found that there were at least 200 new settlers within a 50 mile radius of Barham and Koondrook hence the area was an ideal outlet for the produce. Furthermore due to the absence of a bridge, produce was transported across the river approximately 90 km upstream at Swan Hill 90 km downstream at Echuca (McConnell et al 1994: 11).

Tenders for the construction of a “steel lift bridge on the Murray River at Barham and Koondrook” were called for in the NSW Government Gazette on the 10th of March 1902. The original contract seems to have been secured by Monash and Anderson, who later withdrew, but then appear to have won the final contract when fresh tenders were called for in November of the same year (McConnell et al 1994: 11, 15). The Bridge was under construction by June of 1903, with funding provided jointly by NSW and Victoria (RDPW 1903: 8). The timber for the bridge was obtained from the northeast coast of NSW with the raw material for the iron and steel coming from Scotland and structural members fabricated in Ballarat at the Eureka Iron Works (**figures 5 and 6**) (McConnell et al 1994:13).

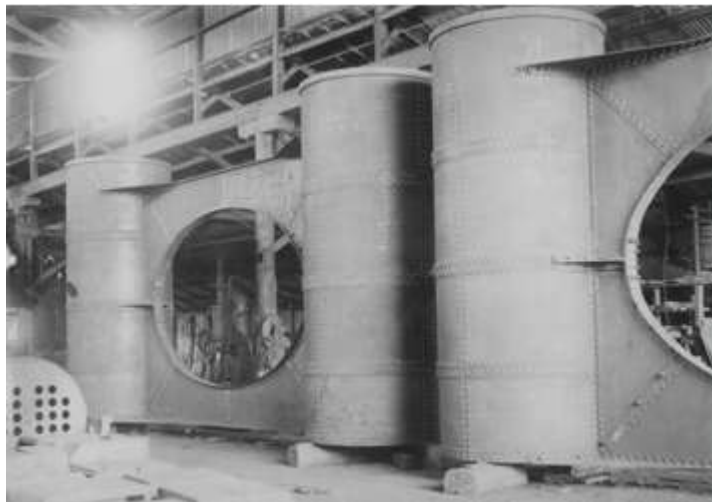

Figure 5: Paired iron cylinders for Barham Bridge prior to shipment from Eureka Ironworks at Ballarat (Reinforced Concrete & Monier Pipe Construction Co Collection, University of Melbourne Archives, BWP/23839).

The cost of the bridge was approximately £11,358 and the payment was covered by both the New South Wales and Victorian Governments. On the 8th of October 1904 the bridge was officially opened with a number of Federal and State members attending the event (**figure 7**). The opening ceremony and banquet were apparently well attended; the enthusiasm of the spectators was such that a crowd of people rushed across the lift span before it had completely closed, causing one of the cogwheels in the lifting gear to break. The lifting gear was shut down for a number of days while a replacement wheel was obtained (McConnell et al 1994: 17).



Figure 6: View of the Bridge during construction in mid 1904 with lift span in place. The near side span has the right hand truss complete, but left hand truss is still under construction. The deck cross-members of the near side span are in place, but not decking (University of Melbourne Archives, UMA/I/6290).



Figure 7: Lift span raised during the official opening of Barham Bridge in September 1904 (University of Melbourne Archives, BWP/23843).

The Barham Bridge was designed by engineer E. M. De Burgh with construction completed in 1904. The design is an adoption of his previous design of Cobram

Bridge and as with Cobram, the design incorporates further improvements on the Hinton and Murwillumbah Bridge designs.

The Barham Koondrook community turned out to acknowledge the centenary of the bridge's opening in 2004 by organising festivities with the bridge as a focus and commemorative a banner was hung from the lift tower. A decorative picket gate was put in place on the deck; this was the original form later replaced with the existing tubular steel gates.



Figure 8: Decorative gate set up on bridge for Centenary celebrations, October 9th and 10th, 2004, note access ladder right side of lift span first attached to bridge in 1923 and replaced at regular intervals.

2.3 Operational history

As with other later movable span bridges built after 1900, the Barham Bridge lift span was used relatively infrequently as river trade, by the period of its construction, was on the decline (Fraser, 2005). Test lifts have been made at regular intervals but accurate records of operational lifts have never been kept.

From the 1990s after more than ten years of drought and a low Murray River, river traffic was at a minimum and the high clearance under the bridge resulted in very few lift requests from river boats or paddle steamers. The lift span remains in regular but infrequent use (see **figures 9** and **10**).

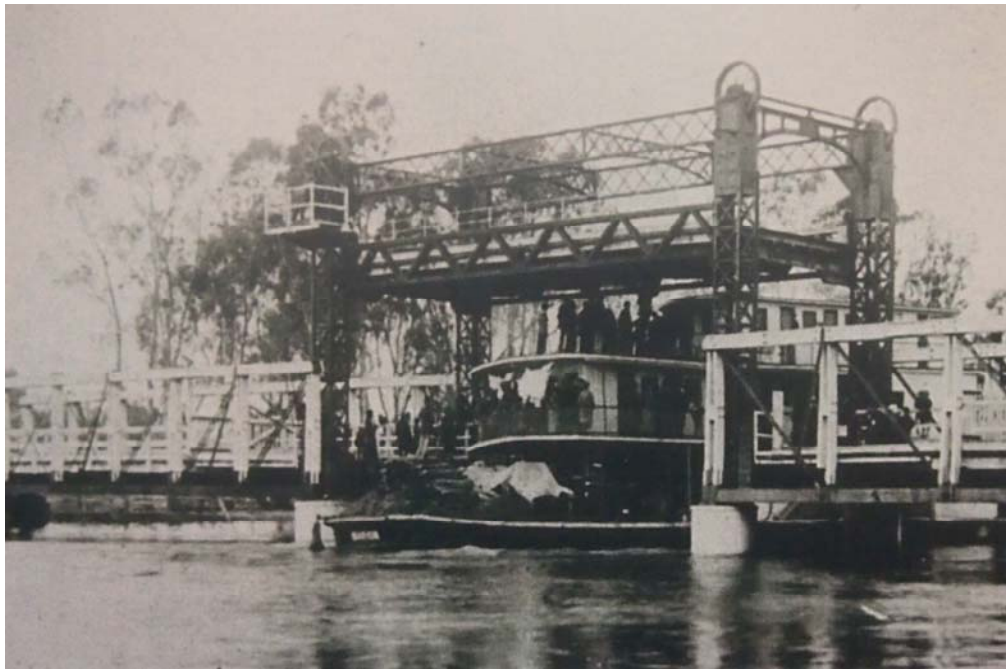

Figure 9: Lift span raised c.1900 (Barham Bridge Centenary Committee).



Figure 10: A test left undertaken in 2012 after repair works (RMS Bridge File).

Motors and electrical components were not originally installed on Barham Bridge. It remained manually operated throughout the initial period of its operation. Since 1997 the opening function of the bridge has been undertaken by Wakool Shire Council and a hydraulic motor has been used to drive the opening mechanism of the bridge. The motor is driven by a portable power pack (fError! Reference source not found.11).



Figure 11: Wakool Council officer with removable power pack to facilitate opening (RMS).

2.4 Maintenance history

Under the Bridge building agreement, NSW and Victoria shared the cost of both construction and maintenance of the Bridge. The replacement of the lifting gear cogwheel was probably the first maintenance work required on Barham Bridge. The bridge deck was damaged some 10 years later when the wheels of a heavy traction engine broke through it, causing the vehicle to be stuck and closing the Bridge to vehicular traffic for a day (McConnell, 2001:48).

In 1935 the NSW Department of Main Roads took over responsibility for bridge maintenance from the Department of Public Works (RTA file 469.1311, part 1). RMS bridge maintenance files include documents dating from 1928; the following is a summary of the maintenance history of the Bridge extracted from those files.

Date	Description	Cost
1923	Height of lift span towers increased by approximately 2 metres adder attached to tower.	n/a
1927	Shire of Kerang requested the use of the Bridge for carrying	n/a

Date	Description	Cost
	electric cables from the electric generating plant at Barham.	
1928	Decking renewed, steelwork repainted, tarring.	£665
1932	Longitudinal running strip recommended. This necessitated adjustment of the lifting gear by loading with concrete blocks.	Est. £282
	New lifting gear required – manufactured by DMR central workshop. Ladder on lift span replaced.	£520 for lifting gear.
	Complete re-decking as well as the replacement of other timbers including stringers, capwales, piles and girders. Load limit of 5 tons placed on the Bridge during repairs. Longitudinal sheeting placed on decking was found to have put the lift span out of balance and new counterweights were needed to rectify this. Renewal of three girders, three stringers and five piles. Bridge repainted. A new abutment A was rebuilt in front of the original.	Est. £14,714
	Renewal of some decking, kerbs, girders, stringers and piles.	£2,700
	Renewal of kerbs, decking, handrails, bracings, walers and girders.	Est. \$18,436
	Diver's report stated that sills in piers 2 and 3 were extensively honeycombed. It was suggested that a steel sheet pile wall be driven around the sills 1ft from them and the space between filled with concrete.	Est. \$37,000
1972	Recommended that a SAT-T-CLIMB system be attached to the Bridge in order to facilitate access for inspections.	\$152
	Steel bridge inspection report – steel bottom chords in span 3 badly corroded, tower bases on piers 2 and 3 rusting inside, lift span weights should be balanced, lubrication needed.	Est.\$9,105
	Steel painted and timber handrails and kerbs in spans 2 and 4. Renewal of some timber in chords, stringers, handrails and decking; some truss members were also replaced. In order to complete the last item of work a Bailey Bridge was established on the structure. Cemented rocks were placed around abutment A.	Not listed
1979	Lift span jammed – shaft and bearing were replaced.	Not listed
	Decking and longitudinal sheeting on lift span and spans 1 and 2 renewed. New counterweight plates to be added to the lifting mechanism and lift span ladder replaced.	Not listed
1984	Renewal of two corbels, raker piles, flood brace, stringers, girders, some kerbing, sheeting and handrail posts. Trusses and handrail painted. Debris cleared from around piers.	\$77,504
1987	All timber stringers supporting lift span deck replaced with steel I-girders.	Not listed
2000	Lift span towers strengthened through welding additional plate sections to the top chords and relocating the iron railings.	Not listed
2012	Lift span operating mechanism repaired and test lifts undertaken	\$800,000
2013	Abutment A, span 1 and pier 1 replaced and upgraded	\$200,000

Table 1: Summary of maintenance of Barham Bridge: Information from RTA File 469.1331.

Details of the upgrading works undertaken in 2013 (and subject of a Section 60 approval) are included in a December 2013 community update (**Appendix A**).

2.5 Physical description of Barham Bridge

Barham Bridge comprises three main spans including one lift span, supported on wrought iron piers. There is a single timber approach span at each end, supported on timber trestle piers. The lift span, which measures 17.8 metres, is of lattice steel construction, similar to the design developed by Percy Allan and first used at Swan Hill nine years previously. Barham Bridge shows some variation from that format and those designs used later for the bridges at Tooleybuc and Abbotsford. Barham Bridge has the counterweights on the main axis side of the supporting columns, while the others have the weights on the cross axis. In addition the cross girders on the top of the structure are unusually curved and decorated. These changes may be due to the fact that the design was undertaken by Ernest de Burgh, who also changed timber trusses from Allan's design to the de Burgh style.

The two other main spans are 31.7 metres in length and are timber trusses of the "de Burgh" type. Ernest de Burgh developed the De Burgh truss as an improvement on the Allan Truss. The truss uses a steel bottom chord and supports steel cross girders and steel longitudinal stringers. The main bridge piers are twin wrought iron columns protected within concrete cofferdams. Except for the centre lift span, the timber deck has been segregated for pedestrian use with a kerb and handrail.



Figure 11: General View of Barham Bridge looking south (RMS).

2.6 Timber truss bridge analysis

The *Timber Truss Bridge Conservation Strategy: Submissions Report and Revised Conservation Strategy* (RMS 2012b) (hereafter referred to as the RMS Strategy) included a review undertaken by RMS with respect to the 48 bridges under its control. Timber truss bridges under the care and control of local councils or other government agencies have not been included in the review. The review and subsequent consultation process is required to provide the RMS with planning certainty on how to best move forward with the management of these structures, including replacements where appropriate and strengthening if and when required over the next 10–15 years. The review also allows RMS to focus on the bridges that are identified as the most appropriate candidates for long-term conservation.

RMS has conducted this review via a four-step assessment process. Each step provided an analysis of attributes that identified and refined a portfolio of bridges to best meet long-term conservation and infrastructure service needs. The four steps developed were:

1. Operability test.
2. Sensitivity analysis.
3. Representative sampling.
4. Balancing analysis.

The Operability test analysed each bridge against a range of critical operational factors to determine whether it was capable, either in its existing state or if structurally upgraded, of performing at an appropriate level of service within its location in the road network into the future. Operationally unsuitable bridges are those where the route must have a bridge with the capacity to accept loads in excess of the structural bridge engineering standard associated with the current general access trucks. It is not possible to upgrade any existing timber truss bridge to meet that capability.

The Sensitivity analysis involved examining five key heritage and five key operational factors for each bridge in order to differentiate and rank structures that were fundamentally similar in many respects. No single factor was determinative. Instead a quantitative non-weighted scoring system allowed the population's conservation and operational potential to be ordered on a scale from high-positive to high-negative, while still recognising the overall heritage significance or the overall operational risks for the portfolio/individual bridge. This step was intended to provide a broad overview to assist the analysis. The analysis confirmed that operable bridges were generally better candidates for conservation (RMS 2012b).

Representative sampling then applied the results of the operability test and the sensitivity analysis to verify that a representative sample of the population was present and adequately captured the inherent variation in the population and the heritage significance of the bridges both collectively and individually. Five dimensions were chosen for examination in considering the representativeness of the sample:

- Historical representation.
- Technical representation.
- Social visibility.
- Aesthetic visibility.
- Spatial distribution.

If there were potential gaps in the sample, consideration was given to bridges identified as 'operationally unsuitable', favouring those with the greatest adaptive reuse potential as conservation candidates. Ideally, no redundant assets will be

identified for conservation due to the substantial management issues represented by such assets (RTA 2011).

The representative sampling step verified that the operable bridges as a group provide a good representative sample of the original in-service timber truss bridge population, adequately reflect the overall bridge population's diversity and provide positive heritage outcomes.

The Balancing analysis checked that the outcome was: consistent with other government policy directions, financially feasible and ultimately deliverable by the RTA. This analysis is set out in detail of the 2011 report. The balancing analysis considered the following matters:

- Meeting heritage asset management policy obligations.
- Providing efficient and effective service delivery.
- Understanding the financial implications of the proposed RTA approach.

The Balancing analysis identified three areas where it is likely the representative sampling for positive heritage outcomes may not reconcile with other government policy directions:

- In the longer term it may not be feasible to support an ideal Statewide spatial distribution of timber truss bridges on the western slopes and plains due to the widespread access requirements of large multi combination trucks. This reflects the uncertainty regarding the future operability of the five local road Dare and Allan truss bridges in the central west as well as Carrathool (on the SHR) on a local road on the south-west plains.
- The representative sampling was undertaken independently of financial and service impacts.

This review of the above analysis (RMS 2012b) demonstrated how difficult it can be to achieve a balance between infrastructure provision and heritage conservation due to the multiple values embodied by each individual bridge, as well as the lack of an established heritage methodology for considering such issues. Timber truss bridges do not lend themselves to adaptation as they deteriorate from environmental factors if not in use. It is thus desirable that these bridges be kept in operation in order to ensure regular maintenance as justified by their continued function within the road network, provided safety to road users can be effectively managed. As a result of its best assessments the RMS is proposing that 26 bridges be retained and 22 bridges be divested from the Section 170 heritage register. This reflects three significant changes resulting from the community consultation program that amend the draft Timber Truss Bridge Strategy (RMS 2012b).

2.7 Timber truss bridge conservation

The future management and conservation of all RMS managed timber truss bridges have been addressed in the Timber Truss Revised Conservation Strategy (2012b) (hereafter referred to as the Strategy). The NSW Heritage Branch has endorsed the Strategy and believes it represents an achievable long term outcome for the management of these bridges. The Strategy sets out how RMS undertook public consultation on its draft strategy for conservation of timber truss road bridges in NSW and to the resolutions of the Heritage Council following its review of the draft November 2010 strategy.

In 2010, the RTA (now RMS) prepared the document *Timber Truss Road Bridges – A Strategic Approach to Conservation* (RTA 2010), which detailed a methodology for

assessing the conservation suitability and approach to managing the 48 remaining timber truss bridges managed by RMS. These bridges have a range of limitations within a modern road network and the RTA 2010 document (and the more recent 2011 Draft) outlines both operational and heritage considerations and applies a methodology to determine which of the 48 bridges represent better candidates for long-term conservation within the road network.

The document from 2010 recommended the conservation of 25 bridges. In the revised Strategy (RMS 2012b) a total of 26 bridges were identified as suitable candidates for long-term conservation while the remaining 22 are bridges that RMS proposes to replace with new structures in the next 10–20 years.

The Strategy accepted the levels of significance identified for the bridges as identified in the MBK Study (1998), as it was felt that these levels of significance had been well established, although for a limited spectrum of significance. The Strategy addressed other aspects of significance where such information was able to differentiate between bridges.

The Strategy (RMS 2012b) acknowledged the rarity of the timber truss bridge population. One of the aims of the strategy is to ensure that the limited resources of RMS are appropriately directed to those bridges that have the best prospects for long term conservation. While the strategy allows for the reduction in the overall number of bridges, those that are to be retained will be subject to rigorous management regimes that will ensure their long-term conservation. Decision-making regarding individual bridges without such a strategic framework is likely to result in continual attrition of bridge numbers.

RMS receives a specific allocation for bridge maintenance and must use this to cover the maintenance costs of the more than 5000 bridges within its care. It has been noted that the timber truss bridges consume a disproportionate share of this budget (RMS 2012b). The Strategy was structured so that operational costs did not influence the analysis or outcome. Implementing the Strategy will not result in substantial savings; rather it will result in funding being directed towards those bridges that are better candidates for conservation.

3 HERITAGE SIGNIFICANCE

3.1 Introduction

'Heritage significance' is a term used to describe the inherent cultural and historical value of an item. Significance may be contained within the fabric of a building or other place, in its setting and its relationship with other nearby items.

The main aim in assessing significance is to produce a succinct statement of significance, which summarises an item's heritage values. The statement is the basis for policies and management structures that will affect the item's future (NSW HO 2001b).

The Bridge has been assessed in a population study in 1998 and this formed the basis for its inclusion on the RMS Section 170 Register and the NSW State Heritage Register which share the same entry for the item's statement of significance.

3.2 McMillan Britton and Kell Pty Limited (MBK), 1998

The heritage significance of Barham Bridge was assessed during a *Study of the comparative significance of all timber truss road bridges in NSW* prepared for the RTA by McMillan Britton and Kell Pty Limited (MBK). Out of the 82 bridges investigated in the study it was ranked 22nd (MBK, 1999:91). It was described as *One of only 2 sites on Murray River with DeBurgh trusses flanking a lift span*. The other site is Cobram Bridge which was ranked 24th and has been converted to a pedestrian bridge. It was ranked 4th of the 10 DeBurgh truss bridges included in the study.

3.3 Statement of cultural significance

The Bridge's entries on the NSW State Heritage Register and RMS Section 170 Register are reproduced in **Appendices B** and **C**. The following entry is taken from the Victorian Heritage Register (**Appendix D**):

The Barham-Koondrook Bridge is of technical (scientific) significance for the innovations used in its design and construction. The De Burgh Truss was developed by Ernest de Burgh as an improvement on the innovative Allen Truss. The bridge is a rare combination of the Percy Allan designed steel central lift-span with composite De Burgh trusses. The only other Murray River bridge to have this configuration is the Cobram Bridge. Only two other were built in New South Wales, over the Paterson River at Hinton and Dunmore, west of Newcastle. No other bridges of this type were built in Victoria.

The Barham-Koondrook Bridge is of historical significance for its associations with John Monash who was one of Australia's most important engineers, and one of the country's most famous soldiers. The Barham-Koondrook Bridge is also of historical significance for its association with the innovative and influential engineer Ernest De Burgh.

The Barham-Koondrook Bridge is of historical significance for its role in facilitating inter-colonial trade between New South Wales and Victoria.

3.4 Heritage Listings

National Heritage List	Not Listed
NSW State Heritage Register	Listed
Wakool Shire Council Local Environmental Plan 2013	Listed
NSW National Trust Register	Listed
Victorian Heritage Register	Listed (H0795)
RMS s.170 Heritage and Conservation Register	Listed

Table 2: Listings with statutory and non-statutory authorities.

Places of heritage value can be subject to different levels of recognition and protection. This protection (at local, State and Commonwealth levels) includes specific measures for the protection of heritage items. The text below provides a summary of the legislative framework at each level of government. As a Statutory body of the NSW Government, RMS has a legal obligation under both State and Commonwealth legislation to effectively manage heritage items it owns or affects.

3.5 NSW Heritage Act

NSW State Heritage Register

The NSW *Heritage Act 1977* is a statutory tool designed to conserve the cultural heritage of NSW and is used to regulate development impacts on the state's heritage assets. Administered by the NSW Heritage Office, the Act details the statutory requirements for protecting historic buildings and places and includes *any place, building, work, relic, movable object, which may be of historic, scientific, cultural, social, archaeological, natural or aesthetic value*. A curtilage map for the item was produced at the time of its listing on the Register in 2000 (**figure 12**).

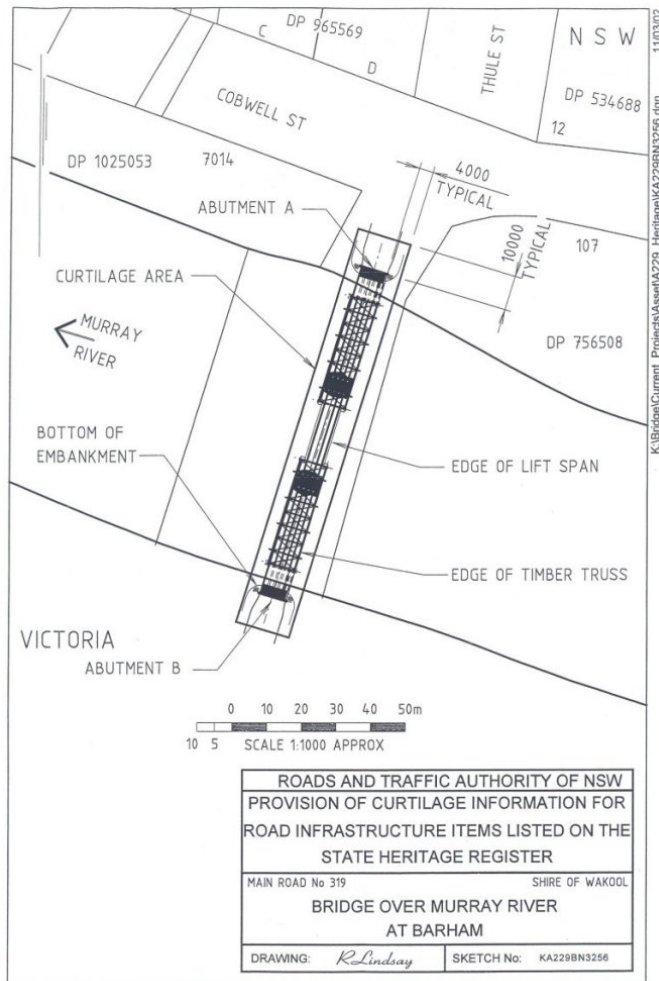

Figure 12: Curtilage map for Barham Bridge NSW State Heritage Register listing.

3.6 Environmental Planning & Assessment Act 1979

The *Environmental Planning & Assessment Act 1979* (EP&A Act) controls land use planning in NSW. The planning system established by the EP&A Act includes Local Environment Plans (LEPs) and other provisions relating to development control. Heritage items are added to a heritage schedule of a LEP often following identification and assessment from a local shire heritage study. These items are then given protection by the heritage provisions within the relevant plan, which will then require consent of Council for certain developments. Barham Bridge is currently listed on the Wakool Shire Council's 2013 LEP.

Environment Protection and Biodiversity Conservation Act

The Commonwealth *Environment Protection and Biodiversity Conservation Act 1999* (EPBC Act) enhances the management and protection of Australia's heritage places. Any action that is likely to have a significant impact on the matters protected under the EPBC Act must be referred to the Commonwealth Environment Minister for further consideration.

The Australian Heritage Database (AHD) includes the National Heritage List, which includes the natural, historic and indigenous places that are of outstanding national heritage value to the Australian nation. The AHD also contains the Commonwealth Heritage List that comprises those places on Commonwealth lands and waters under Australian Government control. Items on both of these lists are protected under the EPBC Act.

Barham Bridge is not included on the National or Commonwealth Heritage lists, under the EPBC Act. No other items are located within the proposal area. No referral is required to the Minister.

3.7 Victorian Heritage Register

Barham-Koondrook Bridge was listed on the Victorian Heritage Register in 2008 and the documentation is included as **Appendix D**. Heritage Victoria utilised the existing NSW State Heritage Register curtilage and in deference to this listing sought only to include the approaches on the Victorian border marked in the yellow box of B1 on Diagram 795 (**figure 13**).

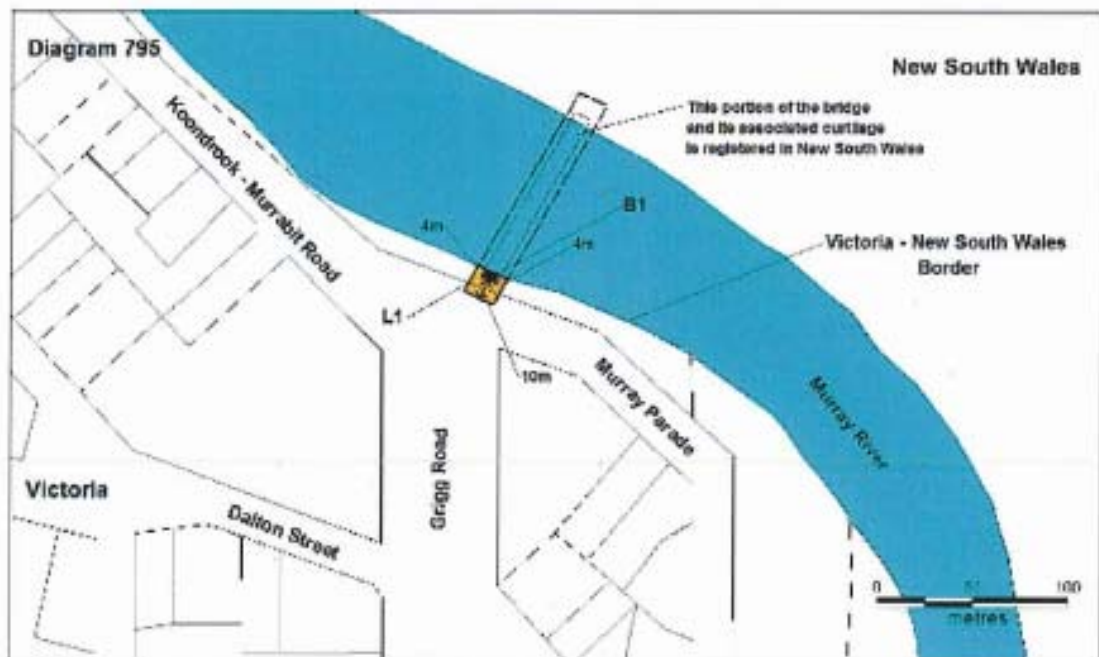

Figure 13: Curtilage map for Barham-Koondrook Bridge in Victorian Heritage Register listing.

4 BRIDGE COMPONENTS

The separate components that make up the Bridge are shown in a general plan of the western elevation in 1902 reproduced below.

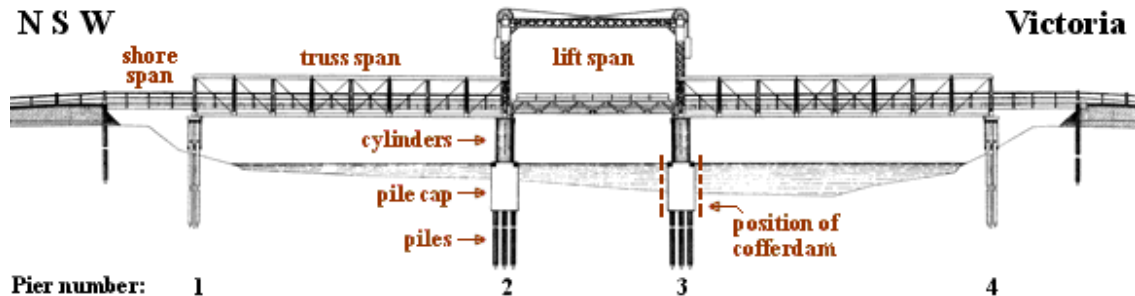

Figure 14: Profile view looking east.

4.1 NSW Abutment (Abutment A)

The existing NSW abutment was built in 2013 and replaced successive timber abutments built from 1958 onwards. The original design for the abutments is of the spill through type. The reduced waterline evident in **figures 15** and **16** has exposed rocks from the former spill through abutment.

The existing NSW abutment consists of timber capwales supported on circular timber piles. The piles extend approximately 5m above existing riverbed level. Wing walls, supported by wing piles extend back approximately 5m at 45 degrees from each side of the abutment. Timber back sheeting installed behind the piles is designed to retain the soil of the approach embankment.



Figure 15: View of Abutment A looking west in 2004 prior to replacement in 2013. Stones from the original spill through abutment can be seen at the base.

4.2 Victorian Abutment (Abutment B)

Abutment B, on the Victorian side of the river, is has very low clearance in comparison to Abutment A which reflects the extent the Victorian approach span has been lengthened to align with bank erosion. It comprises two timber piles and two steel piles, which represents a modification of the original four timber pile

arrangement. The function of the abutments is to retain the fill material of the approach embankments in addition to supporting the timber beam approach spans. This is different to the original abutment design which was a low height timber trestle on driven piles, buried in a spill-through earth formation with hand packed rock on the battered faces.

The major cause of deterioration in abutment timbers is termite infestation and the abutments represent their main point of entry into the rest of the Bridge. Therefore the abutments warrant particular attention to improve and ensure long-term durability.



Figure 16: View of Abutment B detailing its low clearance above the river bank.

4.3 Timber Piers

The timber piers are of standard timber pier design used in the majority of timber road bridges (both truss and beam designs) constructed in NSW. The piers are of relatively standard timber pier design used in the majority of road bridges (both truss and beam designs) constructed in NSW, generally comprising driven timber piles, timber cross bracing, timber headstocks and walers to form an above ground trestle. In order to carry the DeBurgh truss span load, piers 1 and 4 are double trestle piers. Piers carry the load of the Bridge and items crossing it, by a combination of pile end bearing on stiff foundation material and friction along the sides of the piles. The friction also assists the piers to resist uplift forces caused by wind and currents. Pile groups are braced in order to transfer lateral loads to ground level. Timber piers are typically constructed from ironbark, tallowwood or grey box timber, with the exception of piles placed in marine environments. In those instances, turpentine is preferred, as it is unpalatable to marine borers (DMR, 1987:1.46-7).

Piers 1 and 4 support the truss spans (**figure 17**). These piers are relatively typical of piers supporting a truss on one side and a timber girder span on the other. They are also typical of timber trestles that have undergone upgrading and strengthening over time. Pier 1 was replaced in 2013 with a timber pier of similar configuration. Pier 4 consists of four, round section, vertical piles in a group, with crossheads under each truss support. These vertical piles are located on upstream and downstream sides of each timber trestle and represent replacement elements of the timber square-section piles. The piers are laterally braced by square section, twin raking columns on the downstream side. Each truss end rests on three square section corbels supported on four timber capwales. Horizontal timber members (walers) are located near water

level, on either side of the pier trestle. The piers are well braced, with diagonal timber members (braces) running across the trestle. The timber bracing is arranged to brace against the force on the upstream side during flooding. The original trestle is braced as well as the additional piles on both sides of the trestle.



Figure 17: View of the timber trestle Pier 4.

4.4 Iron Cylinder Piers

The piers that support the lift span comprise twin wrought iron cylinders, connected by wrought iron plate diaphragms with an elliptical opening (**figure 18**). This pier system is common for river crossings of this period of construction. The upper portions of the wrought iron caissons were filled with concrete to provide support for the lift towers lift span and timber truss spans. The cylinders were supported on a concrete pile cap, excavated in the riverbed, in turn founded on timber piles driven deep into the riverbed.

Steel sheet piling encloses each pier and this extends approximately one metre above normal water level. Sheet piling encasement was installed in the 1970s as a cofferdam to protect the concrete pile caps from undermining due to scour. The bottom edge of the steel plate bracing between cylinders at Pier 3 has some corrosion loss.



Figure 18: View of the iron Piers 2 and 3.

4.5 Lift Span

The lift span is a vertical type and consists of a steel Warren type truss on each side, joined by cross girders (**figure 19**). The riveted built-up steel cross girders are supported on saddle plates riveted to the bottom chord of the truss at the bottom chord panel points. All cross girders except the end ones have a convex soffit. These cross girders support steel stringers topped with timber decking and sheeting. The four towers consist of a wrought iron lattice column system. Steel lattice truss girders brace the tops of the four towers both longitudinally and transversely. The underside of the upper lattice girder transverse bracing is curved. The counterweights are located on the main Bridge axis side of the lifting towers.



Figure 19: View of the Warren truss of the lift span on the upstream side.

In 1923 the lift span towers were extended by approximately 2 metres. In 2000 the lift span trusses were strengthened by welding additional plate sections to the top chords, replacing some rivets with replica cup head bolts and relocating the iron railings. In 1974 reinforcing plates were installed on the bottom chord as were extra gusset plates at each end of the truss.

The steel counterweights are as per the original design, however, steel tubular gates have replaced the original timber picket gates. There is no separate footway on the lift span. Here, pedestrians share the deck with the traffic, whereby access is provided to the road deck from the adjoining footways of the truss spans.

4.6 De Burgh Truss spans

Spans 2 and 4 are timber truss spans. The truss type employed in this Bridge is the de Burgh design. The bottom chords of the truss spans are constructed with continuous parallel steel plates that are strengthened by lattice box sections within the end panels. The steel plate elements of the chord are spliced together by riveted twin fishplates. The box sections within the end panels consist of steel angles that are riveted to the inner faces of the plates and then fixed together by horizontal cross lattice bracing.

The top chord comprises twin timber members of dimension 356mm by 178mm (14 inch by 7 inch) spaced approximately 200mm apart with cast iron anchor blocks. The

chord contains four lengths of these twin members, bolted together with flanged steel fish plates (or splice plates) on the outer faces of the timbers to form a continuous beam. The splice plates are as originally designed. Continuous steel peaked sheeting has been added to the top surface of the top chord to shed rainwater, aimed at preventing rotting along this element. This work is a recent addition.

The vertical compression struts of the trusses consist of two timber posts that sit on a steel frame riveted to the bottom chord. A timber spacer block, larger than those at the top and bottom, is located between the posts at mid height and owing to its size, induces a slight outward bow. The posts are bolted together at the base, at the central spacer block and at the top.

Tension members in a de Burgh truss (apart from the bottom chord) comprise diagonal steel rods bolted through cast iron anchor blocks on the top of the top chord at each vertical strut (3 types of anchor block) and attached to the bottom chord with a steel pin located directly below the vertical struts. The system of tension members (or tie rods) in the Bridge reflects the magnitude of the forces in the members in particular areas of the truss. As the greatest shear force is located at the ends of each truss, larger diameter double tie rods have been used. With the panels closer to the centre of the truss, smaller diameter double tie rods are used. At the two central panels, single tie rods are used to cross brace the panels. The rods pass through the cast iron anchor blocks separating the top chord members above the vertical struts.

External sway braces are connected between the top chord and tapered steel outriggers bolted to the ends of the steel cross girders at every second panel point. There are no sway braces at the ends of the trusses. This bracing is provided in order to prevent lateral deflection of the top chords of each truss and increase stability without the need for overhead bracing.

The cross girders are supported on wrought iron saddle plates riveted to the bottom chord at the truss panel points, which also support the vertical timber, struts. The cross girders at the ends of the truss spans are timber members. The inner seven cross girders consist of a riveted built-up steel I-beam with a convex soffit. These steel cross girders are of two different lengths, with the longer version extended at each end by tapered steel outriggers to support the sway braces. The longer steel cross girders occur at the first and third inner cross girders from either end of the truss span. Steel beams replaced the original timber stringers in the mid 1980s. A walkway is located on the upstream side of the Bridge and consists of plywood decking known as "Bridgewood". The walkway is separated from the traffic by a timber ordinance fence.

The timber used for truss members was the best hardwood timber available for both strength and durability. The type of hardwood used was almost exclusively ironbark, but other timbers such as tallowwood and grey box were sometimes used. When these bridges were first built, large, old growth hardwood trees were in plentiful supply, and the timber, being slow-grown (rather than fast-grown, in a plantation), was dense and durable. Today, replacement timber of equivalent quality is very difficult to obtain (DMR, 1987:1.47).



Figure 20: View of southern truss span (Span 4).

4.7 Approach Spans

Spans 1 and 5 form the approach spans at the northern and southern ends of the Bridge respectively. Each span has two steel girders supporting the walkway and four round timber girders and one square section timber edge girder supporting the road. Over Piers 1 and 4, the junction between the approach spans and the truss spans, Spans 1 and 5 are supported on square timber corbels stacked three high. The two parallel steel girders that support the walkway at the timber approach spans represent a modification of the original timber beam arrangement.

4.8 Decking

The entire Bridge, excluding the walkway, is decked with 50 millimetre thick longitudinal sheeting supported on transverse timber decking. The transverse decking comprises timber planking laid perpendicular to the stringers in the truss spans and lift span. The existing transverse decking is approximately 125 millimetres deep, which is likely to be of a similar depth to that of the original timbers. The original bridge drawings show timber decking, significantly skewed, on the lift span and slightly skewed on the truss and approach spans.

Although longitudinal sheeting is almost a universal feature on timber bridges today, it is a departure from the original design at this site. Bridges of this era were usually designed with transverse decking only. The introduction of longitudinal sheeting was favoured for two reasons: maintenance (durability) and strength. The maintenance issue related to the fact that vehicular traffic creates longitudinal wear patterns in localised areas that would affect every piece of the decking. Therefore the entire deck of transverse decked bridges would require frequent replacement, even though the majority of each piece of decking would still be in good condition. With longitudinal sheeting, individual sheets wear differentially depending upon their location, and can be replaced without re-decking the entire structure.

The use of longitudinal sheeting also significantly improves the distribution of wheel loads to the supporting decking. In most instances the traditional transverse timber decking (without sheeting) would not satisfy current design loads unless it were significantly increased in depth. The transverse decking is essentially the primary

load-carrying member in the deck design and transfers load to the longitudinal girders beneath it, which in turn transfer the load to the substructure.

The layout of the transverse deck sheeting differs from the original, in that the sheets have been placed several centimetres apart, instead of tight against each other. These spaces were inserted between the timbers in order to improve drainage of water through the deck and thus reduce the risk of deterioration of the deck timbers. The entire surface of the deck has been flush sealed to provide a better travelling surface and to improve its waterproofing qualities by reducing the effects of rapid moisture changes. Timber kerbing is situated along the edges of the deck in the original 150 x 150 millimetre kerb design.

The walkway, located on the upstream side of the Bridge, consists of plywood decking known as “Bridgewood”. The walkway is separated from the traffic at all spans, except the lift span by a timber ordinance fence. At the lift span rubber markers, attached to the timber deck, delineate the roadway/walkway boundary.

4.9 Traffic and pedestrian barrier

Behind the timber kerbs on both edges of the deck, at the truss spans and approach spans, is traditional timber ordinance railing, approximately 1 metre high. The existing timber railing has no structural capacity and represents no real barrier, except to pedestrians or travelling stock. The ordinance railing terminates with timber end posts at each end of the Bridge structure. At the lift span the railing comprises a steel tubular system, fixed to the top flange of the top chord of the main trusses.



Figure 21: View of deck on lift and truss spans.

4.10 Criteria for assigning levels of significance to bridge elements

While each of the elements that comprise the Bridge contributes to its overall significance, it is a useful management tool to separate the Bridge into its components and examine the heritage significance of each. This process allows for more informed analysis of what constitutes significant form and fabric, or what fabric is of little significance, or intrusive.

Table 3 below, provides a guide to the grading of significance of items or places of heritage value and is directly derived from the NSW Heritage Office Heritage Manual (revised 2001).

Grading	Justification	Status
A: Exceptional	Rare or outstanding place or item of state and/or national significance, exhibiting a high degree of intactness or other such quality and a high degree of interpretability, although alteration or degradation may be evident.	Fulfils criteria for listing on the NSW State Heritage Register.
B: Considerable/High	Featuring a high degree of original or early fabric or demonstrative of a key part of the place's significance, with a degree of alteration that does not unduly detract from that significance.	Fulfils criteria for listing on the NSW State Heritage Inventory or Local Environment Plan.
C: Some/Moderate	Altered or modified elements, or elements with little historic value that contribute to the overall significance or the working place.	
D: Little/Low	Difficult or unable to be interpreted, not an important function, often subject to alteration, detracting from significance of the working place.	
	Damaging to the site's overall significance, an aspect of the site's significance and/or significant fabric.	

Table 3: Criteria for assigning levels of significance to bridge elements.

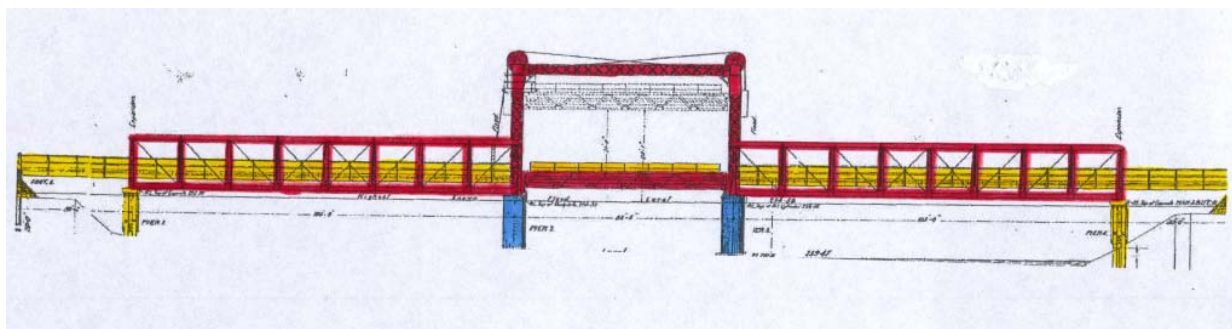

Figure 22: Profile of Barham Bridge illustrating the elements described in the text. The NSW approach span and Abutment A are on the left hand side.

4.11 Schedule of significant forms and fabric

4.11.1 Abutments

The form and fabric of the abutments is of MODERATE significance.

The two bridge abutments, Abutment A on the northern (NSW) side of the Murray River and Abutment B on the southern (Victorian) side, are constructed of vertical timber driven piles sheathed at the rear with horizontal timbers. Two of the timber piles have been replaced with sheet piles at Abutment B. Above the piles on each abutment is a headstock.

As noted above in **Section 4.1** alterations to both the original abutments have been carried out, converting the original spill-through form to a standard wall abutment, replacing various timber elements and installing metal flashing to protect the headstocks. Abutment A is not the original abutment. The current Abutment A was erected in front of the original abutment due to stability problems.

The function of the abutments is to retain the fill material of the approach embankments in addition to supporting the timber beam approach and truss spans. The abutments are of a standard design (modified by use of different materials) used in the majority of road bridges (both truss and beam designs) constructed in NSW. Both abutments have undergone various repairs and modifications to design since the construction of the Bridge.

4.11.2 Timber Piers

The form and fabric of the timber piers is of MODERATE significance. The Bridge uses a combination of both timber and metal piers to support the various spans. Piers 1 and 4 are of timber construction and support the outer ends of the truss spans. They are of the same design and are typical timber trestle piers, which have been upgraded and strengthened. They consist of four round timber piles reinforced with square cut timber cross bracing and a timber bottom wale. Although it is unlikely that any of the original members remain in the piers the integrity of the design has been maintained.

4.11.3 Iron Piers

The form and fabric of the wrought iron piers is of HIGH significance. Piers 2 and 3 are wrought iron cylinder piers painted with grey micaceous iron oxide epoxy paint to help arrest further corrosion. Both piers appear to be in original condition and have been surrounded by a steel sheet pile "coffer dam". This cofferdam was put in place in the 1970s in order to protect the bases of the piers from erosion. It appears that no modifications have been made to the original design of these piers and overall their condition is sound.

4.11.4 Lift Span

The form and fabric of the lift span is of EXCEPTIONAL significance. The steel lift span is a design by E.M. DeBurgh and consists of a steel Warren type truss on each side linked by steel cross girders at 9' 8 ½" spacings that in turn support steel longitudinal stringers, timber decking and longitudinal sheeting. The height of the lift span towers was extended by 6'6" in 1923. In addition some minor strengthening has been carried out, and the lift span continues to operate at irregular intervals.

4.11.5 DeBurgh Truss spans

The form and fabric of the truss spans is of EXCEPTIONAL significance. The truss type employed in this Bridge is the de Burgh design. This truss type was developed by Ernest DeBurgh as an improvement on the Allan truss. The truss uses a steel bottom chord and supports steel cross girders and steel longitudinal stringers. The de Burgh truss is one of a sequence of timber truss designs developed by the Public Works Department engineers in the late 19th and early 20th centuries in an attempt to create a timber truss that was durable enough to have a useful working life of between 30 and 50 years. At the same time it had to be able to be repaired and maintained under traffic, that is, without having to close the bridge to conduct routine maintenance works such as the replacement of truss members (DMR, 1987:2.1).

The de Burgh truss was the first composite truss type. Prior to the evolution of the de Burgh truss, all structural members of timber truss bridges had been timber. The use of a steel bottom chord in the de Burgh truss reflects the increased availability of steel in Australia by the final decade of the 19th century. Splices in the top chords of these trusses reflected a growing shortage of suitable, available hardwood timber. De Burgh trusses were only constructed for a relatively short period, between 1899 and 1904, after which it was superseded by the Dare truss, which incorporated many improvements to truss design to the extent that no more De Burgh trusses were built after this time (DMR, 1987:1.38-1.43).

The truss span's bottom chords comprise continuous parallel steel plates, strengthened by lattice box sections within the end panels. The top chord of each truss comprises four lengths of double members, spliced together with flanged steel fish plates to form a continuous beam. There are no original timber members left in the top chords.

Diagonal steel rods bolted through steel anchor blocks on the top of the top chord and attached to the bottom chord with a steel pin located directly below the vertical struts act as tension members. The riveted steel cross girders on the Bridge are attached to the bottom chord at the truss panel points and all are original components. Approximately half the timber cross girders have been replaced with steel rectangular hollow section cross girders.

The Barham Bridge is one of only two de Burgh truss bridges surviving with a lift span. The other is Cobram Bridge upstream on the Murray River. Overall the truss spans are in fair to good condition with some minor additions to the original design but generally the retention of the integrity of the original truss design is good.

4.11.6 Approach Spans

The form and fabric of the approaches is of MODERATE significance.

The approaches to the truss and lift sections, Spans 1 at the Barham end and Span 5 at the Koondrook end are traditional timber beam structures. Each span was designed with five timber girders, the outer girders being square and the inner girders with a round section.

Each of the spans now has four round timber longitudinal girders (otherwise referred to as stringers) and one square section girder, representing a change from the original design of square section timber edge girders. The footway on the western side of the Bridge is supported by a pair of steel girders. The timber beam approach spans provide an important element of the Bridge's appeal and frame the truss spans at either end.

4.11.7 Decking

The form and fabric of the decking is of LOW significance.

The entire Bridge has longitudinal timber sheeting supported on transverse timber decking which as noted above is thicker than the original decking. The longitudinal sheeting is also different to the original design for the Bridge but was introduced for most timber bridges to reduce maintenance requirements and also to increase the strength of the decking. In most instances the traditional transverse timber decking (without sheeting) would not satisfy current design loads unless it were significantly increased in depth.

As the deck represents one of the primary maintenance features and it is likely that it has been replaced numerous times since the Bridge was constructed. In this regard, due to the diminishing availability of the higher quality timbers the existing decking is probably not comprised of timber from one of the previously mentioned high durability species.

The layout of the transverse deck sheeting also differs from the original and the surface has been flush sealed. The flush seal across the deck has since deteriorated significantly.

4.11.8 Pedestrian and traffic barrier

The form and fabric of the bridge railings are of MODERATE significance.

Both approach spans and the truss spans have timber upright posts and handrails painted white. The existing railing has no structural capacity and represents no real barrier, except to pedestrians or travelling stock. The ordnance railing terminates with timber end posts at each end of the Bridge structure. At the lift span the railing comprises a steel tubular system, fixed to the top surface of the top chord of the main trusses and painted grey.

All timber railings on the Barham Bridge were upgraded in the 1980s and minor changes have been made to the original design of the footway fence on truss and approach spans.

5 PROPOSED WORKS

5.1 Background to the proposed works

The RMS proposes to strengthen the trusses and deck of the Bridge as they do not meet current load requirements. The primary intention of the proposed works is to upgrade the Bridge to the required level and also to minimize the future routine maintenance requirements of the Bridge. A principal focus of the latter is the reduction of the need for timber. Timber required to continue the repairs of heritage bridges has become increasingly difficult to obtain during the past 20 years as the last of the old growth forests have either been harvested or preserved. The RMS is now in the position that it must balance its heritage obligations with a commitment to ecologically sustainable development, as timber shortages dictate that the current situation is not sustainable.

5.2 Refurbishment and strengthening of De Burgh truss spans

As previously described the De Burgh truss spans are of composite construction featuring large size timber in the top chord and verticals and wrought iron in the bottom chord. The different components of the truss are detailed in **figure 6**.

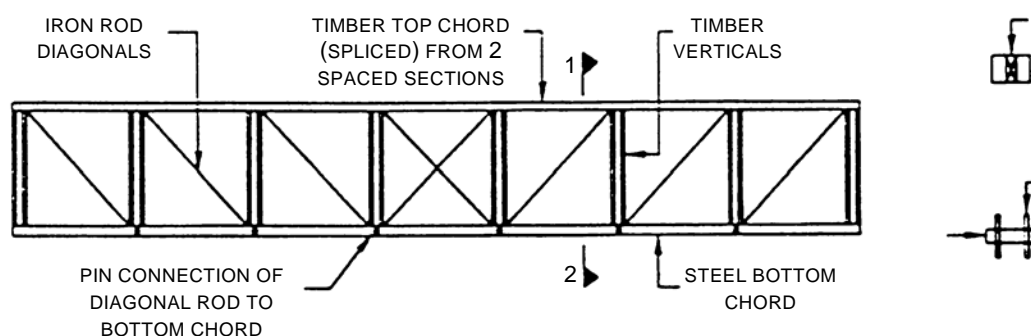

Figure 23: Profile view of a De Burgh truss span.

The dimensions of all timber components would be retained unchanged. However, in order to accommodate the required load capacity increases to the trusses, it is required to make modification to a number of the metal components.

Modelling of the Bridge under load, coupled with maintenance records of the bridge identify a number of structural shortcomings of the De Burgh truss. The potential for these shortcomings to come into effect are referred to as modes of failure; in order of likelihood these shortcomings are cross girders, bottom chords and tension rods

diagonals. In order to upgrade the Bridge to meet current load requirements each of these components needs some degree of strengthening.

The cross girders would be strengthened as part of the deck refurbishment of the De Burgh truss as described in the section on Stress Laminated Timber (SLT decking).

Upgrading tension rods

The diagonal tension rods in a De Burgh truss consist of wrought iron rods often referred to as “tension rods”. The rods are in groups of two throughout the truss with the exception of the central bay where there are two single rods crossed over to form an “X” – see **figure 24**. Each rod is supported by a wrought iron washer plate on the top and bottom chords.

The increase in width in the rods does not require the modification of the shoes so is considered readily reversible. In the scale of the bridge this alteration would not be distinguishable.

Figure 24: View of a De Burgh truss span detailing the tension rods.

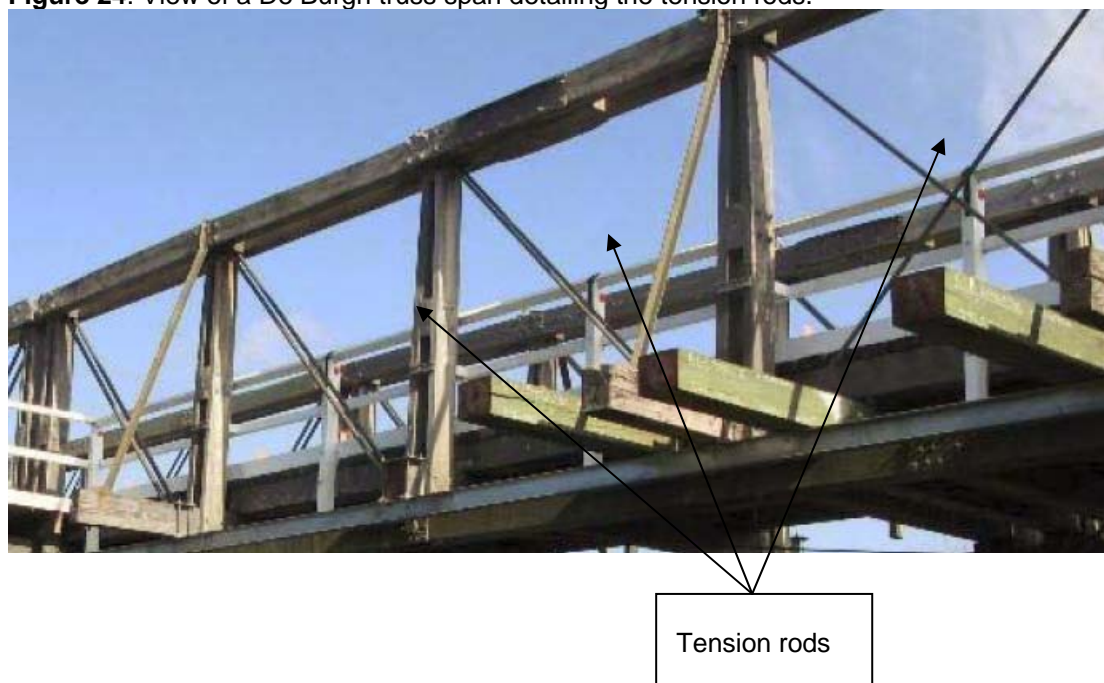

There is widespread evidence of corrosion on the existing wrought iron tension rods in the form of “waisting” or loss of cross section in the area of the bottom chords. While like for like replacement of these components would be a preferred heritage option the inability to obtain wrought iron requires the RMS to substitute similar material instead.

It is therefore proposed to replace all tension rods with grade 300 mild steel with rolled threads but no upsetting of ends. These replacement rods would be visually identical to the existing and will feature special oversize nuts to match the existing nuts. The new rods would satisfy ultimate load conditions.

Concerns have been raised about the structural adequacy of the two single tension rods that frame the central bay. Two options have been considered for addressing this:

- 1/ Keep the rods the same 41mm diameter but double the number of central rods.

2/ Increase the thickness of the tension rods in each central bay of the two trusses from 41mm to 56mm and keep them single.

Option 2 is considered preferential as it would enable the retention of a single component only rather than having to install a second tension rod at this location meaning there would be no visual change. Furthermore, there would be no requirement to modify the connections in the top and bottom chords to accommodate a second rod. The new shoes would be identical in dimensions to the existing ensuring that this modification would not be evident to the casual observer (**Appendix E Sheet 11**).

Strengthening and replacement of the truss would require that the thickness of all other tension rods be similarly increased. This dimensional increase is proportional to the required load capacity increase and is detailed in **Appendix E Sheet 9**.

Bottom chords

The bottom chords of the truss spans are constructed with continuous parallel steel plates that are strengthened by lattice box sections within the end panels. As part of the upgrading works steel would be retained for this purpose and steel splicing plates also.

General replacement of defective cast iron components and repainting

Beyond the proposed alteration of the components described above all remaining metal components would be investigated for reuse in the reinstated in the truss rehabilitation. Any broken or severely corroded metal parts would be replaced in a like for like manner.

A selection of these metal parts would be retained for teaching purposes for RMS engineers and also to facilitate the fabrication of moulds for replacement parts in future.

It is proposed that the De Burgh trusses of the refurbished bridge be painted in heritage colours; timber elements to be painted white and steel elements painted black. Flashing would be utilised along the top chords to provide weather protection to the new timber elements installed thus ensuring the longevity of this diminishing resource.

All of the truss works described above are consistent with those proposed for Middle Falbrook Bridge over Glennies Creek (S60 application no: 2014/260/014) and approved in March 2014.

5.3 Refurbishment of the Deck on the De Burgh truss spans

The existing deck on the bridge is in poor condition and is in need of refurbishment or replacing (**figure 25**). As the existing timber beam approach spans are not of sufficient strength to meet the current load requirements, a more rigid decking system is required. With regards to the proposed replacement of the decking system it should be noted in **section 4.11.7** that the significance of the deck was noted as low in the overall context of the bridge.

Furthermore the existing deck structure of longitudinal sheeting is different to the original design for the Bridge but was introduced for most timber bridges to reduce maintenance requirements and also to increase the strength of the decking. In most instances the traditional transverse timber decking (without sheeting) would not

satisfy current design loads unless it were significantly increased in depth. The proposed option therefore stands as the next generation of change aimed at reducing maintenance requirements and increasing the strength of the decking.

The refurbishment of the timber deck in a “like for like” manner such that the form and fabric of the approaches would remain unchanged has been considered but rejected. While this would appear to be the best option from a heritage perspective it is not considered adequate as it does not address the issue that the Bridge does not meet current load requirements.



Figure 25: Detailed view of deck detailing its poor condition with splits and decayed timber.

Deck strengthening on the truss spans involves the replacement of the existing timber deck with a transversely stressed Stress Laminated Timber (SLT) decking system. It consists of a series of timber laminates that are held rigid by the regular tightening of a stressing rod that runs transversely through the deck as shown in **figure 26**.



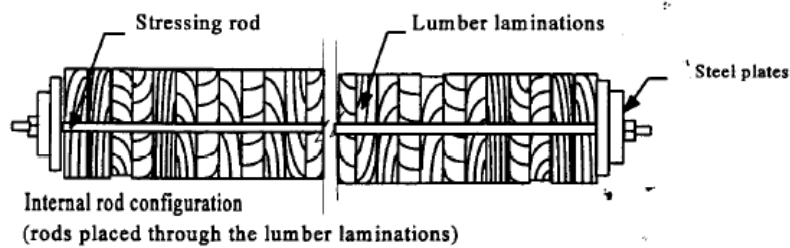

Figure 26: Cross sectional view of SLT decking system detailing timber laminates and stressing rod.

Invented in Canada, it was introduced to Australia (primarily NSW) in the 1990s and has been approved in the past to re-deck timber truss bridges listed on the State Heritage Register including the De Burgh truss bridge over the MacDonald River at St Albans, Hinton Bridge (**figure 27**), Coonamit Bridge and the Wallaby Rocks Bridge.

Installation of an SLT decking system would require removal of the longitudinal sheeting, transverse decking timbers and stringers currently in place on the Bridge. The subsequent loss in depth of the deck would be accommodated by raising the position of the cross girders slightly as shown in **Appendix E Sheets 3 to 8**. This would enable the road level to remain at the same height. The cross girders to be utilised would be slightly longer than those presently in use, in order to retain the existing lateral bracing which would correspondingly need to be fixed at an increased angle as shown.

The new SLT decking system would comprise a continuous timber slab composed of 35 millimetre thick laminates (with a depth dependent on design requirements). The laminates are aligned vertically and stressed together to form a continuous deck. While the installation of an SLT deck would change the form of the decking system on the Bridge, the fabric would remain the same.

SLT has a number of advantages over the current timber plank decking. It provides a more rigid surface for holding a sprayed bitumen and stone chip seal, providing a stronger and smoother running surface for traffic and lessens its dynamic effects. In addition, it has the advantage of being waterproof, so that rainwater would run off the edges of the deck preventing rapid deterioration of not only the deck but also the elements of the span below. This is an inherent flaw of the more traditional decking system, as there is no way to effectively waterproof it so that water does not run through and pool in the channels and crevices of the timberwork and steelwork below. The deck surface would be topped with a rubberised bitumen seal.



Figure 27: Two views of capacity upgrade of Hinton Bridge, detailing the change from timber planks to an SLT decking system topped with a rubberised bitumen seal.

Traditionally, a timber kerb rests on the deck surface close to the edge of the deck in order to prevent the wheels of vehicles crossing the bridge hitting the trusses (**figure 21**). As SLT decking is designed so that water runs off the edges of the deck, it is not possible to have the kerb sitting flush with the deck as it would prevent water run off. In order to overcome this, it is proposed to install a steel rectangular hollow section (RHS) kerb that is raised approximately 50 millimetres above the surface of the deck.

The installation of a new SLT decking system would require the replacement of all the timber cross girders on the De Burgh truss spans with new timber cross girders of larger section, or hollow steel girders of similar dimensions to the existing timber cross girders. Timber cross girders are elements that are most susceptible to deterioration. Replacement of these under SLT is extremely difficult, and would cause major disruption to traffic. The introduction of the cross girders would require that the levels of the abutments and piers be lowered by 200 millimetres to accommodate this new element and retain the deck at its existing level.

Furthermore, given the present difficulty experienced by the RMS in acquiring large section hardwood timber, it is proposed that hollow steel girders would be used for this purpose. The concept drawing for this proposed strengthening is presented in **Appendix E Sheet 2**. This option is completely reversible.

Additionally, it is proposed that the end cross girders on the De Burgh truss spans be lengthened from the present 7.2m to 10.2m (as shown in **Appendix E Sheet 6**). This is in order to make possible the extension of the monorails that were installed some years previously. The function of the monorails is to support gantries that are used in the maintenance of the underside of the Bridge. The existing sway braces would be angled out from the truss to provide increased lateral support and the method of attachment of the sway braces to the top chord is proposed to be modified slightly to provide increased lateral support (**Appendix E Sheet 7**).

5.4 Replacement of the Victorian approach span and abutment

In order to best address the ongoing issues of erosion and scour on the river bank it is proposed to build a new abutment behind the existing Abutment B. This would also facilitate construction of the abutment with minimum traffic disruptions; an essential

planning requirement as the nearest detour for heavy vehicles is over 100km distance.

The placement of a new abutment behind the existing would necessitate the extension of the approach span which is 9m in length. Two options have been considered.

Option A: Extend the approach span to 11m

This option would involve construction of the new abutment 2m behind the current abutment. This would place the new abutment face almost flush with the existing profile of the river bank. To retain this flush profile and thus reduce the risk of future scour undermining the structure it would need to present a square face to the river and would be a wall type abutment. Abutment would be built in concrete in order to ensure durability of this component to impacts of moisture and termite ingress.

Option B: Extend the approach span to 14m

This option would involve construction of the new abutment 5m behind the current abutment. This setback enables space for a replacement of the existing timber abutment to a spill through abutment. Construction of this wall type abutment is shown in the plans for this option in **Appendix E Sheet 2**.

It is considered that **Option B** best meets the objective of the project of providing a long-term solution to the erosion at the NSW abutment to ensure that this critical bridge component is not undermined by scour. In addition to an improved engineering performance this option could mark a return of this component to a profile closer to its original design. An image of a similar original spill through abutment on a timber truss bridge is shown in **figure 28**.

It is worth noting that this component of the work is essentially identical to that which was previously approved by OEH in 2012 for Abutment A and span 1 and subsequently undertaken in 2013 (**Appendix A**).



Figure 28: Abutment A at St Albans Bridge.

The option to lengthen the existing approach span and provide spill through abutment is preferred based on the construction issues with minimum traffic disruptions.

The use of a spill through abutment is a return to the original design. While good conservation practice requires respect for all periods, the spill through solution respects the river regime and erosion characteristics. This may well have been in the mind of the original designer.

Due to the proposed increase in length of the approach span a conventional timber beam deck cannot be used. Instead a composite steel girder system would be utilised as the decking system

The steel girder option for the approach span decking is chosen in view of the following.

1. Provides comparatively easy and economical method for constructing the deck under the traffic restrictions.
2. Usually, the timber/concrete composite deck is suitable up to a maximum of 12m spans. Since the required span length is 14m, the steel girder with composite deck option is the only upgrading alternative.
3. Shallower depth of the deck beams which will match the existing timber bridge deck beam depth is possible only with steel composite deck.

A similar activity has recently been approved on another SHR listed timber truss bridge. The Clarence Town Bridge comprises a modified approach span of 45 feet (14.75m) length. This span proved too long for timber girders and was replaced with a composite steel girder span.

5.4 Replacement of Pier 4

As can be seen in **figure 17**, Pier 4 is currently made up of a “nest” of timber piers and the timber trestle structure has been altered from the original configuration. Given the poor condition of the timber components it is proposed to replace Pier 4 in line to rationalise the structural support system. Instead of rebuilding the Pier in its existing configuration, a number of alterations from the existing have been proposed in order to accommodate the current legal vehicle loading.

Initially, the below ground components of the vertical timber columns would be replaced with structurally superior and more durable concrete elements.

Secondly, a concrete pilecap designed to minimise hydraulic impact on the Murray River, would be constructed to a level that would balance the following constraints:

- minimise the amount of timber subjected to the dilapidating effect of river height fluctuation and
- minimise impact on the aesthetic and heritage value of the structure.

Currently the existing timber piles provide fixity to the pier to carry the lateral loads. But the lateral load capacity of the piles to the current design loads is inadequate. Therefore concrete piles and concrete pile cap is used in the foundations to transfer the loads.

Modification to timber columns and braces

On completion of the pilecap the existing above ground portion of the pier trestles would be reconstructed over the new pilecap. Additional timber raking members would now be added in line with the existing pier framework system.

Two options have been examined for the reconstruction of the timber trestle piers.

Option 1

Removal of central single column and replacement with two double columns. This option further involves the installation of steel shoes at the base of the columns to provide full fixity in line with the existing structural system. The proposed steel shoes provided are in line with those previously approved and since constructed on the SHR listed timber truss bridge at St Albans Bridge (**figure 14**).



Figure 29: View of Pier 4 of St Albans Bridge detailing pilecap and steel shoes at base of timber trestle. A tall spill through abutment is visible at left.

Option 2

Removal of central single column and replacement with a single double column (see **Appendix E Sheet 3**). As a variation on the steel shoes of Option 1 consideration has been given to the installation of hinge connections. Hinge connections have previously been approved and since constructed on the SHR listed timber truss Coorei Bridge near Dungog (**figure 30**).



Figure 30: View of Pier 3 of Coorei Bridge detailing pilecap and steel shoes at base of timber trestle. The capwale is just visible at the top of the pier.

Option 2 would provide increased load capacity over the existing pier and would satisfy the structural performance demands. The hinge connections of Option 2 provide partial fixity to the pilecap only and are considered adequate for the hydraulic

conditions at Barham Bridge. This option is considered a preferable heritage outcome in that it preserves the existing layout of the pier.

It is worth noting that this component of the work is essentially identical to that which was previously approved by OEH in 2012 for Pier 1 and subsequently undertaken in 2013 (**Appendix A**).

5.4 Replacement of the Barrier railing

In considering an appropriate design for the new truss and approach span decking, the RMS is obliged to comply with the current 1996 AUSTRROADS Bridge Design Code. The code requires that level 2 safety barriers (continuous steel safety barrier for the entire length of the Bridge) be installed on new bridge elements on this Bridge. **Figure 5** shows the existing timber railing. While the proposed barrier would be similar in appearance and have a similar visual impact to the existing ordinance railing, it would be composed of steel members as shown in **Appendix E Sheets 2** and **8**. The barriers would also serve to protect the exceptionally significant trusses from vehicle impact. The upgraded span 1 is shown in **figure 30** prior to the safety barriers being painted white to match the existing colour scheme of the Bridge as shown on Wallaby Rocks Bridge in **figure 31**.



Figure 30: View completed NSW approach span (span 1) of Barham Bridge in March 2014 prior to painting of barrier railing white.



Figure 31: View of Wallaby Rocks Bridge, north of Bathurst following completion of upgrading works in 2010 showing SLT decking and steel guardrails.

5.5 Fabrication method for truss spans

In order to ensure least disruption to the community and driving public the trusses would be built under cover in sheds near the bridge site. This would ensure that all components are structurally sound before being fitted onto the bridge (**figure 32**). This method of fabrication also removes the risk of working at heights to RMS employees.



Figure 32: Replacement truss span of Hinton Bridge under construction in 2006.

Once completed the trusses are trucked to site, the existing trusses removed and the replacement trusses craned into position. **Figure 33** illustrates this process underway as part of the Dunmore Bridge upgrade which received the Colin Crisp award from Engineers Australia for Heritage Conservation.



Figure 33: Truss being removed from Dunmore Bridge in 2013 prior to a replacement truss being manoeuvred into position.

6 Statement of Heritage Impact

The following questions are presented in the *NSW Heritage Manual* document “Statements of Heritage Impact” as the minimum response required to properly address proposals on heritage items which would result in the modification of the item.

6.1 What aspects of the Proposal respect or enhance the heritage significance of the Barham Bridge?

The Proposal respects the heritage significance of the Barham Bridge and aims to ensure that it remains operating as a road bridge and that it retains its historical, social and aesthetic significance.

The proposal aims to enhance the existing significance of the bridge with visually and technically unobtrusive strengthening works of structurally critical elements which will ensure that the bridge is able to operate with no load restrictions placed upon it. This will ensure that the technical, historical and social significance of the Bridge as a functioning example of a significant evolutionary link in the development of timber road bridges in NSW remains intact.

The Proposal seeks to respect and enhance the aesthetic significance of the Bridge by keeping the form of the trusses, deck and abutments as close as possible to the original design and restoring all other deteriorated fabrics to their original condition.

6.2 What aspects of the Proposal could have a detrimental effect on the heritage significance of the Barham Bridge?

The Proposal would require the removal of some significant fabric from the Barham Bridge and the addition of non-original fabrics in selected critical locations.

The replacement of selected critical elements with non-original fabrics is required because the original design incorporating the original fabric is unable to meet current load capacity requirements.

From a conservation perspective it is preferable to keep the Bridge operating, even if it requires replacing original fabric, than to have the Bridge taken out of use. The heritage impact of the bridge being removed from service as a road bridge is assessed as being greater than the heritage impact of replacing the critical elements as detailed below.

6.2.1 Refurbishment and strengthening of De Burgh truss spans

Strengthening and replacement of the truss would require that the thickness of all tension rods in the truss be increased. This dimensional increase is proportional to the required load capacity increase and is detailed in **Appendix E Sheet 10**.

The heritage impact of this alteration has therefore been assessed as low. This impact is mitigated by the fact that the change is reversible should circumstances become amenable.

6.2.2 Replacement and upgrade of the deck on the truss spans and approach spans

The Proposal would result in the replacement of the existing timber deck on the truss spans and approach spans with an SLT deck. This alteration would result in a change of form of the approach span superstructure while retaining the essential fabric (i.e. timber). The heritage impact has been assessed as low.

6.2.3 Replacement of the barrier railing

The rehabilitation of the bridge provides the opportunity to upgrade the safety barrier to current safety standards and it is proposed that a continuous steel safety barrier extending the full length of the Bridge should replace the present timber ordinance fencing. The proposed safety barrier system is sympathetic in that it echoes the form of the existing ordinance fencing and timber kerbing, but is much stronger. Painting the barrier in accordance with the Bridge's original colour scheme would serve to reduce the visual impact of the proposed alteration. The rectangular hollow section kerb that is to replace the timber kerb would be painted in accordance with the original colour scheme. The heritage impact has been assessed as moderate as the modification incorporates a change in fabric of a significant historic element.

6.3 Have more sympathetic solutions been considered and discounted? Why?

All proposed strengthening works have been assessed against the "replace like for like" option that would retain the existing form and fabric of the bridge. In all cases this option would not result in the essential increase in structural capacity required to meet current legal load standards. In some cases, the proposed modifications also support the Authority's desire to wherever possible balance environmental and social responsibilities with heritage commitments.

The RMS preferred strengthening options retain the essential form and much of the original fabric of the Bridge while replacing structurally critical bridge elements with visually unobtrusive, structurally superior permanent elements.

6.3.1 Refurbishment and strengthening of De Burgh Allan truss spans

The "do nothing regarding truss strengthening" option is not feasible in this case.

The original design using timber fabric does not meet current legal load capacity requirements. In order to fulfil its function as a crossing of Murray River, the structural capacity of the Barham Bridge must be increased to allow the passage of legal loads that have increased considerably since the original design was completed.

Increasing the structural capacity of the bottom chords using only timber is not feasible given current legal loads.

For the cross girders, the options of installing a) Larger size cross section timber elements and b) steel reinforced timber elements, have been considered and eliminated as not addressing either structural capacity needs and or the problems associated with maintenance of these structurally critical truss elements.

The insertion of visually unobtrusive steel laminates in the bottom chord is considered to be the most heritage sympathetic option available.

6.3.2 Replacement and upgrade of the deck on the truss and approach spans

The most sympathetic solution from a heritage perspective would be to retain the Bridge in its existing condition by replacing the approach span deck like with like. However, this solution is not feasible, as it does not address the issue of structural inadequacy. From both operational and heritage points of view it is desirable that this structure is strengthened. The installation of an SLT deck on the truss and approach spans would significantly increase the strength of the structure and in addition would lower the level of maintenance that is currently required.

6.4 Is the alteration sympathetic to the Bridge? In what way?

6.4.1 Refurbishment and strengthening of De Burgh truss spans

The proposal to strengthen the De Burgh trusses is sympathetic in that the technical and aesthetic impact would be minor and would not be noticeable to the casual observer. Changes would be documented and reversible in the event that circumstances become amenable. These critical strengthening works would allow the bridge to carry out the function it was intended for which is to carry legal traffic loads. Without the strengthening works the bridge would have to continue operating under restrictive load limits.

6.4.2 Replacement and upgrade of the truss and approach spans

The proposal to install an SLT deck on the truss and approach spans is sympathetic, as it does not impact on any rare or significant technical achievement or fabric and is aesthetically unobtrusive. The supporting timber girders currently in use would be retained.

6.4.3 Replacement of the barrier railing

The proposed safety barrier system is sympathetic in that it echoes the form of the existing ordinance fencing and timber kerbing, but is much stronger. Painting the barrier in accordance with the Bridge's existing colour scheme would serve to reduce the visual impact of the proposed alterations.

7 Conclusion and recommendations

The proposal to upgrade Barham Bridge is not considered to lead to a significant impact in accordance with the NSW *Heritage Act 1977*, *Environmental Planning and Assessment Act 1979*, and the Commonwealth *Environment Protection and Biodiversity Conservation Act 1999*, in terms of heritage.

The proposed strengthening works would ensure that Barham Bridge continues to operate as a functioning road bridge with no load restrictions placed upon it. Furthermore, the proposed works will ensure that routine maintenance on the Bridge and the need for replacement timber is reduced to a minimum. Over the past 20 years hardwood timber of suitable quality (strength and durability class one) has become increasingly difficult to obtain. The severity of this shortage is better understood when it is considered that the useful lifespan in a bridge of ironbark, tallowwood or grey gum is only around 30 years. Many of the proposed works are aimed at addressing this shortage and offering solutions for the future by trying to extend the lifespan of the existing timber elements.

It is considered that the proposed works would not result in any significant reduction in the heritage value of Barham Bridge. While some of the proposed works are to take place on elements of the Bridge rated as high or moderate significance, taken as a whole they are to be carried out in a manner that is sympathetic to the character of the Bridge. The proposed modifications would bring the Bridge into line with its current level of usage in the most sympathetic manner available and would avoid the necessity of replacing the Bridge.

The following recommendations are made for the proposed activity:

- The RMS lodges a Section 60 application with the Heritage Council of NSW in order to conduct the proposed upgrading works. This SOHI would form part of the application.
- An archival recording be prepared for Barham Bridge. This should follow the guidelines for Items of State Heritage Significance as outlined in the NSW Heritage Branch publication *How to Prepare Archival Records of Heritage Items*.
- Placement of interpretive signage at the bridge site consistent with existing heritage signage currently used throughout the Wakool Shire.
- Barham Bridge should be included in the proposed RMS Interpretation Strategy/publication.
- In the unlikely event any archaeological remains are discovered, works must cease in the vicinity and the *RMS Unexpected Finds Procedure* is to be implemented.

8 References

- Australia ICOMOS (1999) *The Burra Charter (The Australia ICOMOS Charter for Places of Cultural Significance)* Canberra.
- Dare, H 1903 "Recent road-bridge practice in New South Wales" *Proceedings of the Institution of Civil Engineers* 155.4:382-4
- DMR 1987 *Timber Truss Bridge Maintenance Handbook*
- Fraser, D 1985 "Movable span bridges in New South Wales prior to 1915" *Multi-Disciplinary Engineering Transactions Industrial Engineers Australia* GE9.2:71-81
- Grant, E.J. 1970 *Walking with time: the story of the Wakool country*. Abacada: Melbourne
- Heritage Office and Department of Urban Affairs and Planning 1996a *Regional Histories*, Heritage Office and Department of Urban Affairs and Planning
- Heritage Office and Department of Urban Affairs and Planning 1996b *Statements of Heritage Impact*, Heritage Office and Department of Urban Affairs and Planning
- Main Roads 1953 "Movable bridges on Main Roads in New South Wales" *Main Roads* 19.2: 36-40
- McConnell, E. (ed) 2001 1914 *The Border Journal* 24
- McConnell, E., Alexander, O. and Bird, H. (eds) 1994 1904 *The Border Journal* 18
- McMillan Britton and Kell Pty Limited (MBK) (1998) *Study of the comparative significance of all timber truss road bridges in NSW* prepared for the RTA
- NSW Heritage Office (2005) *State Agency Heritage Guide: Management of Heritage Assets by NSW Government Agencies*. Sydney, NSW.
- NSW Heritage Office (2001) *Assessing Heritage Significance: A NSW Heritage Manual Update*.
- NSW Heritage Office (1996) *Statements of Heritage Impact*. Sydney, NSW.
- RMS (2012) *Timber Truss Bridge Conservation Strategy: Submissions Report and Revised Conservation Strategy*.
- NSW Roads and Traffic Authority, 1999 "Barham Bridge, Murray River" *RTA Section 170 Heritage Register*, database entry for Barham Bridge
- O'Connor, C. 1985 *Spanning Two Centuries: Historic Bridges of Australia*, University of Queensland Press, Brisbane
- Painter, G. 1993 *A Different River*. Hyland House: South Melbourne
- Report of the Department of Public Works (NSW) 1903-1905
- RTA (2011) *Timber Truss Road Brides: A Strategic Approach to Conservation*.
- RTA (2010) *RTA Timber Truss Bridge Strategy. Appendix C – De Burgh Truss Bridge Profiles*.

Appendix A:

Barham Koondrook Bridge restoration works community update, December 2013

**Appendix B:
NSW State Heritage Register listing**

Barham Bridge over Murray River

Item

Name of Item: Barham Bridge over Murray River
Type of Item: Built
Group/Collection: Transport - Land
Category: Road Bridge
Location: Lat: 144.12470887 Long: -35.63054187
Primary Address: Main Road 319, Barham, NSW 2732
Local Govt. Area: Wakool

Property Description:

Lot/Volume Code	Lot/Volume Number	Section Number	Plan/Folio Code	Plan/Folio Number
-----------------	-------------------	----------------	-----------------	-------------------

All Addresses

Street Address	Suburb/Town	LGA	Parish	County	Type
Main Road 319	Barham	Wakool			Primary
Thule Street (off)	Barham	Wakool			Alternate
Cobwell Street (off)	Barham	Wakool			Alternate

Owner/s

Organisation Name	Owner Category	Date Ownership Updated
Wakool Shire Council	Local Government	

Statement of Significance

Barham bridge has significance under all four criteria - Historical, Aesthetic, Technical and Social. The significance of the bridge lies in its location, for setting, and materials. The form and setting have aesthetic and social significance. The bridge may have higher overall significance as a member of the Murray Crossing Group, as a representative of a rare example of a representative type.

Date Significance Updated: 28 Jun 05

Note: There are incomplete details for a number of items listed in NSW. The Heritage Branch intends to develop or upgrade statements of significance and other information for these items as resources become available.

Description

Designer/Maker: Department of Public Works

Builder/Maker: John Monash

Construction Years: 1904 - 1904

Physical Description: Barham bridge is timber truss, steel lift span, bridge, generally two lanes wide across the Murray River between Barham in NSW and Koondrook in Victoria. The main axis of the bridge is N-S. There are three main spans including one lift span, supported on cast iron piers. There is one timber approach span at each end, supported on timber trestle piers. The lift span (17.8m) is of lattice steel construction, both the for tower and the main girder. The design is similar to that developed by Percy Allan and first used at Swan Hill nine years previously, but shows some variation from that layout, and those used later at Tooleybuc and Abbotsford bridges. The Barham Bridge has the counterweights on the main axis side of the supporting columns, while the others have them on the cross axis. The cross girders on the top of the structure are unusually curved and decorated. The changes may be due to the fact that the design was undertaken under Ernest de Burgh who

had also changed timber trusses from Percy Allan's design. The two other main spans (31.7m) are timber trusses of the 'de Burgh' Type. This truss was developed by Ernest de Burgh as an improvement on the Allen Truss. The truss used a steel bottom chord. The truss supports steel cross girders and steel longitudinal stringers. The deck is timber. The approach spans (9.1m) are timber girders on timber trestle piers. The deck is timber. A section of the deck has been segregated for pedestrians with a kerb and handrail on all spans except the lift span. The main piers are cast iron and are protected by cofferdams. The bridge has a clearance over normal water level of 5.1m.

Physical Condition and/or Archaeological Potential:

The bridge is in good condition having been extensively repaired in recent years, due to a major rehabilitation of the timber trusses.

Date Condition Updated: 15 May 98

Current Use:

Road bridge

Former Use:

Road bridge

History

Historical Notes:

The Murray around Barham was settled by graziers, mainly from Victoria, in the 1840s. By 1850 all the really desirable water-frontages on both sides of the Murray had been taken up as far upstream as Barham while the open plain to the north in New South Wales was only notionally divided into undeveloped backblocks. Barham station itself (named after the maiden name of the wife of the first grazier, E B Green, had a 32 kilometre frontage on the Murray, carrying a modest head of cattle in the mid Victorian period under a series of owners. With similar developments on the Loddon River, which converges with the Murray north of Barham, a crossing of the Murray was needed and a ferry was provided for stock and people. In 1902 it was agreed that a bridge with a lift span should be built, thanks to local political pressure on both the NSW and Commonwealth governments. The first piles were driven in 1903 and the bridge opened in 1905.

Barham lies in the Wakool Irrigation District, opened in 1935. This was the first such district in the state, with extensive, partial irrigation designed to provide water for the maximum number of graziers to ensure a regular supply of fattened lambs. In 1949 an intensive irrigation area within the district made rice farming feasible, increasing local heavy traffic. There have been particularly severe problems from salinisation, however, in the last quarter-century.

Historic Themes

Australian Theme (abbrev)	New South Wales Theme	Local Theme
3. Economy - Developing local, regional and national economies	Transport - Activities associated with the moving of people and goods from one place to another, and systems for the provision of such movements	(none) -

Assessment of Significance

SHR Criteria a)

[Historical Significance]

The Barham Bridge has historical significance as a rare example of a type of bridge which shows the evolving pattern of bridge design in Australia. The De Burgh timber bridge was only built for a brief period between 1899 and 1904. There are only nine remaining, and only two associated with lift spans, Barham and Cobram. These two

bridges are also the only examples of 'De Burgh' lift spans. The bridge was built by Monash and Anderson. The bridge has historical significance through the association of John Monash with the bridge. Monash is arguably both one of Australia's most famous engineers, as well as one of the country's most famous soldiers.

SHR Criteria c)

[Aesthetic Significance]

The Barham bridge has aesthetic significance due to its outstanding setting and landmark qualities. The bridge provides a gateway to NSW and the town of Barham. It dominates the towns due to its height and mass, providing the major landmark in the district. The setting is particularly fine, situated on the edge of the town and crossing the river amidst parklike lands and trees.

SHR Criteria d)

[Social Significance]

The Barham bridge has high significance to the local and district residents as the gateway between Barham and Koondrook, NSW and Victoria. As the towns are not large there is considerable commuting across the bridge for services that are not duplicated in both towns. The bridge also provides a focal point between town and river. The river is the main geographical feature in the area, and the centre for most recreation. The bridge acts as a reminder of river transport and attracts large crowds wherever river traffic passes through. For example, one lady, who has seen hundreds of river bots pass through the bridge, still rushes to see each new opening.

Assessment Criteria

Items are assessed against the  [State Heritage Register \(SHR\) Criteria](#) to determine the level of significance. Refer to the Listings below for the level of statutory protection.

Procedures /Exemptions

Section of Act	Description	Title	Comments	Action Date
57(2)	Exemption to allow work	Standard Exemptions	<p>SCHEDULE OF STANDARD EXEMPTIONS HERITAGE ACT 1977 Notice of Order Under Section 57 (2) of the Heritage Act 1977</p> <p>I, the Minister for Planning, pursuant to subsection 57(2) of the Heritage Act 1977, on the recommendation of the Heritage Council of New South Wales, do by this Order:</p> <p>1. revoke the Schedule of Exemptions to subsection 57(1) of the Heritage Act made under subsection 57(2) and published in the Government Gazette on 22 February 2008; and</p> <p>2. grant standard exemptions from subsection 57(1) of the Heritage Act 1977, described in the Schedule attached.</p> <p>FRANK SARTOR Minister for Planning Sydney, 11 July 2008</p> <p>To view the schedule click on the Standard Exemptions for Works Requiring Heritage Council Approval link below.</p>	Sep 5 2008



[Standard Exemptions](#) for Works Requiring Heritage Council Approval

Listings

Heritage Listing	Listing Title	Listing Number	Gazette Date	Gazette Number	Gazette Page
<i>Heritage Act - State Heritage Register</i>		01456	20 Jun 00	-	-
<i>Heritage Act - s. 170 NSW State agency heritage register</i>	Roads & Traffic S.170				

References, Internet links & Images

Type	Author	Year	Title	Internet Links
Tourism		2007	Barham Bridge over Murray River	Click here
Tourism	Attraction Homepage	2007	Barham Bridge over Murray River	Click here
Written	I Jack	1986	Regional Histories of NSW	
Written	G Serle	1982	John Monash: A Biography	
Written	R.B. Roland	1960	The Riverina: People and Properties	
Written			Border Journal	

Note: Internet links may be to web pages, documents or images.



(Click on Thumbnail for Full Size Image and Image Details)

**Appendix C:
RMS Section 170 listing**

Barham Bridge over Murray River

Item

Name of Item	Barham Bridge over Murray River
Item Number	4301079
Type of Item	Built
Item Sub-Type	NSW DeBurgh Truss Bridges
Roadloc	
Address	MR 319 ****, Barham 2732
Local Government Area	Wakool
Owner	Local Government
Current Use	Road Bridge
Former Use	Road Bridge

Statement of significance

Statement of significance	<p>Barham bridge has significance under all four criteria - Historical, Aesthetic, Technical and Social.</p> <p>The significance of the bridge lies in its location, for setting, and materials.</p> <p>The form and setting have aesthetic and social significance.</p> <p>This bridge has been assessed as being of State significance.</p>
Date Significance Updated	15 May 1998

Description

Designer	Department of Public Works
Builder	John Monash
Construction years	**** - 1904
Physical description	<p>Barham bridge is timber truss, steel lift span, bridge, generally two lanes wide across the Murray River between Barham in NSW and Koondrook in Victoria. The main axis of the bridge is N-S.</p> <p>There are three main spans including one lift span, supported on cast iron piers. There is one timber approach span at each end, supported on timber trestle piers.</p> <p>The lift span (17.8m) is of lattice steel construction, both the for tower and</p>

the main girder. The design is similar to that developed by Percy Allan and first used at Swan Hill nine years previously, but shows some variation from that layout, and those used later at Tooleybuc and Abbotsford bridges. The Barham Bridge has the counterweights on the main axis side of the supporting columns, while the others have them on the cross axis. The cross girders on the top of the structure are unusually curved and decorated.

The changes may be due to the fact that the design was undertaken under Ernest de Burgh who had also changed timber trusses from Percy Allan's design.

The two other main spans (31.7m) are timber trusses of the 'de Burgh' type. This truss was developed by Ernest de Burgh as an improvement on the Allen Truss. The truss used a steel bottom chord. The truss supports steel cross girders and steel longitudinal stringers. The deck is timber.

The approach spans (9.1m) are timber girders on timber trestle piers. the deck is timber.

A section of the deck has been segregated for pedestrians with a kerb and handrail on all spans except the lift span.

The main piers are cast iron and are protected by cofferdams.

The bridge has a clearance over normal water level of 5.1m.

Physical Condition and/or Archaeological Potential	The bridge is in good condition having been extensively repaired in recent years, due to a major rehabilitation of the timber trusses.
Modifications and dates	N/A
Date condition updated	15 May 1998

History

Historical notes

The Murray around Barham was settled by graziers, mainly from Victoria, in the 1840s. by 1850 all the really desirable water-frontages on both sides of the Murray had been taken up as far upstream as Barham while the open plain to the north in New South Wales was only notionally divided into undeveloped backblocks.

Barham station itself (named after the maiden name of the wife of the first grazier, E B Green, had a 32 kilometre frontage on the Murray, carrying a modest head of cattle in the mid Victorian period under a series of owners. With similar developments on the Loddon River, which converges with the Murray north of Barham, a crossing of the Murray was needed and a ferry was provided for stock and people.

In 1902 it was agreed that a bridge with a lift span should be built, thanks to local political pressure on both the NSW and Commonwealth governments. The first piles were driven in 1903 and the bridge opened in 1905.

Barham lies in the Wakool Irrigation District, opened in 1935. This was the first such district in the state, with extensive, partial irrigation designed to provide water for the maximum number of graziers to ensure a regular supply of fattened lambs. In 1949 an intensive irrigation area within the district made rice farming feasible, increasing local heavy traffic. there have been particularly severe problems from salientian, however, in the last quarter-century.

Listings

Heritage Listing	Reference Number	Gazette Number	Gazette Page
Local Environmental Plan			
Heritage Act - s.170 NSW State agency heritage register			
Heritage Act - State Heritage Register			
National Trust of Australia register			

Assessment of Significance

Historical Significance	The Barham Bridge has historical significance as a rare example of a type of bridge which shows the evolving pattern of bridge design in Australia. The De Burgh timber bridge was only built for a brief period between 1899 and 1904. There are only nine remaining, and only two associated with lift spans, Barham and Cobram. These two bridges are also the only examples of 'De Burgh' lift spans. The bridge was built by Monash and Anderson. The bridge has historical significance through the association of John Monash with the bridge. Monash is arguably both one of Australia's most famous engineers, as well as one of the country's most famous soldiers.
Aesthetic Significance	The Barham bridge has aesthetic significance due to its outstanding setting and landmark qualities. The bridge provides a gateway to NSW and the town of Barham. It dominates the towns due to its height and mass, providing the major landmark in the district. The setting is particularly fine, situated on the edge of the town and crossing the river amidst parklike lands and trees.
Social Significance	The Barham bridge has high significance to the local and district residents as the gateway between Barham and Koondrook, NSW and Victoria. As the towns are not large there is considerable commuting across the bridge for services that are not duplicated in both towns. The bridge also provides a focal point between town and river. The river is the main geographical feature in the area, and the centre for most recreation. The bridge acts as a reminder of river transport and attracts large crowds wherever river traffic passes through. For example, one lady, who has seen hundreds of river bots pass through he bridge, still rushes to see each new opening.
Technical Significance	
Integrity/Intactness	****
Representativeness	****
Rarity	****
Assessed Significance	State

References

Type	Author	Year	Title
Written	Serle G	1982	John Monash: A Biography
Written	R.I. Jack	1996	Regional Histories of NSW
Written		0	Border Journal
Written	R.B. Roland	1960	The Riverina: People and Properties

Study details

Title	Year	Author	Inspected by	Guidelines used
Murray Crossings Heritage Study	1998	Hughes Trueman Reinhold		Yes

Custom fields

RTA Region	South West
Bridge Number	3256
CARMS File Number	469.1331
Property Number	****
Conservation Management Plan	****

Images



Barham Bridge over Murray River

Appendix D: Victorian Heritage Register listing

Appendix E: Plans of proposed works

