



**Installation Instruction  
ESD-4871-AU-5/09**

**Termination for Screened  
3-Core XLPE  
Insulated Cables - 11kV  
with Composite Sheath**

**95-240mm<sup>2</sup>**

**Type: IXSU-F / OXSU-F**

ENDORSED BY	SIGNATURE	DATE
<b>Wilfred Leung</b> Principal Engineer—Mains RailCorp		22. 6. 2009

APPROVED BY	SIGNATURE	DATE
<b>Neal Hook</b> Chief Engineer - Electrical Systems RailCorp		17/8/2009

APPROVED BY	SIGNATURE	DATE
<b>Andrew Thompson</b> Product Manager Tyco Electronics		20/8/03

# OXSU-FRCP05

Qty: 1

## Kit Contents

---

3	x	HVOT-50/16-300/242	Non Trk Tubing HV Red 300 Long Coated
6	x	205W325-103/89	Skirt (Shed) - Red - Adhesive
2	x	S1085-3-300	Low Temp Sealant-Red-300Lg - 50 Wide
3	x	S1085-1-150	Low Temp Sealant-Red-150Lg - 25 Wide
3	x	S1189-1-100	Void Filling Mastic 20 x 100mm Yellow
3	x	EPPA-004	Cleaning Tissue
1	x	EPPA-029-3-1000	Tie Wire 1000mm Long
3	x	CNTM-42/16-1000/U	Conductive Insulating Tubing Uncoated
1	x	402R248-18-R01/89	Conductive Breakout Coated
3	x	BLMT-95/240-13	Mechanical Shear Bolt Lug
1	x	ESD-4871-AU-5/09	Installation Instruction

---

Tyco Electronics  
Energy Division  
Dulmison Pty Ltd  
ABN 56 000 129 573  
Unit 2, No 3 Corella Close  
Berkeley Vale NSW 2261

02 4389 6000 tel  
02 4389 6061 fax  
[www.tycoelectronics.com](http://www.tycoelectronics.com)

Date: 27/05/2009  
ESD-1573-AU  
Page : 1 of 1

**Energy Division**

 **Tyco Electronics**

## **Before Starting**

**Check to ensure that the kit you are going to use fits the cable.**

**Refer to the kit label and the title of the installation instruction.**

**Components or working steps may have been improved since you last installed this product.**

**Carefully read and follow the steps in the installation instruction.**

## **General Instructions**

**Use a propane (preferred) or butane gas torch.**

**Ensure the torch is always used in a well-ventilated environment.**

**Adjust the torch to obtain a soft blue flame with a yellow tip.**

**Pencil-like blue flames should be avoided.**

**Keep the torch aimed in the shrink direction to preheat the material.**

**Keep the flame moving continuously to avoid scorching the material.**

**Clean and degrease all parts that will come into contact with adhesive.**

**If a solvent is used follow the manufacturer's handling instructions.**

**Tubing should be cut smoothly with a sharp knife leaving no jagged edges.**

**Start shrinking the tubing at the position recommended in the instruction.**

**Ensure that the tubing is shrunk smoothly all around before continuing along the cable.**

**Tubing should be smooth and wrinkle free with inner components clearly defined.**

The Information contained in these installation instructions is for use only by installers trained to make electrical power installations and is intended to describe the correct method of installation for this product. However, Tyco Electronics has no control over the field conditions which influence product installation. It is the user's responsibility to determine the suitability of the installation method in the user's field conditions. Tyco Electronics' only obligations are those in Tyco Electronics' standard Conditions of Sale for this product and in no case will Tyco Electronics be liable for any other incidental, indirect or consequential damages arising from the use or misuse of the products. Raychem, TE Logo and Tyco Electronics are trade marks.

# Cable Preparation

## A. Cables with wire shield

Table 1 - Crimp Lug

	95 to 240
	a
	[mm]
11kV indoor / outdoor	200

Table 2 - Mechanical Lug BLMT

	95 to 240
BLMT	a
(range mm <sup>2</sup> )	[mm]
11kV indoor / outdoor	185

Wrap one layer of red sealant tape (50mm wide) with slight tension starting at the end of the inner sheath cutback, downwards for 80 mm. Bend the shielding wires from each core back onto the oversheath. Avoid crossing individual wires. Temporarily fix the shielding wires to the oversheath.

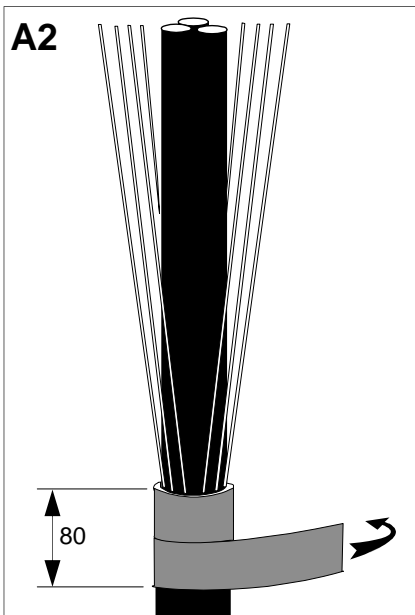

Remove any fillers up to the end of the inner sheath cutback. Bend and shape the cores into their final position. Cut the cores to the required length. Thoroughly remove the core screen according to dimension a (see table 1) for crimp lugs. For mechanical lugs see table 2. The surface of the insulation should be free from all traces of conductive material. Smooth out any irregularities. **Note:** Do not nick the insulation.

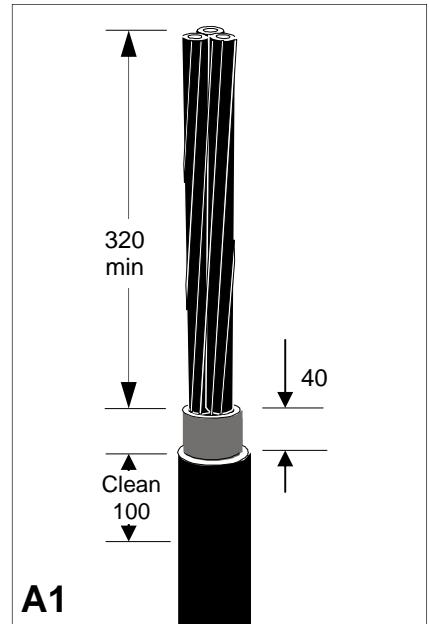
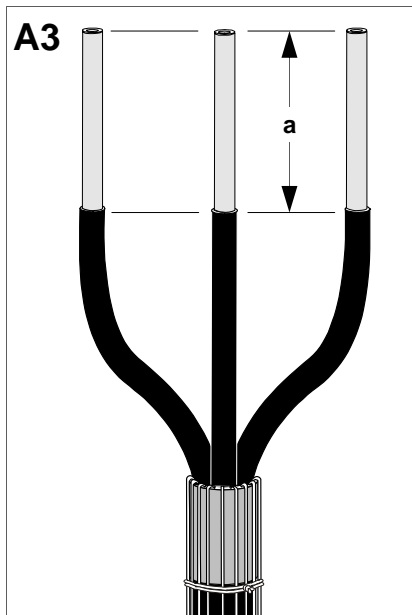

Cut the cable and remove both the layers of composite sheath for 320mm minimum. Remove the outer layer of composite sheath for 40mm. Leave enough length to set the cores into their final position. Degrease and clean the end of the oversheath for about 100 mm using the cleaning tissue provided in the kit.

Wrap one layer of red sealant tape (50mm wide) over the screen wires for 80mm. Mark the core screen 40 mm below the screen cut. Measure the distance c of each individual core and cut the conductive tubing accordingly.

**Continue with step 5.**

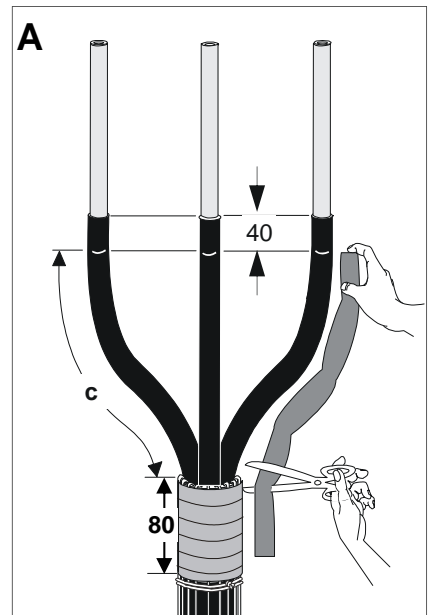

## Completion of Termination

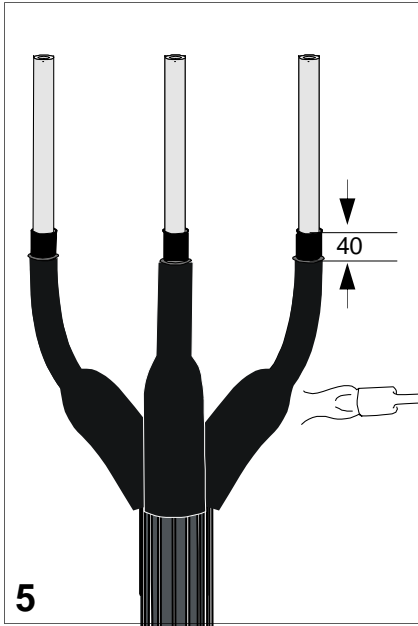

Position the conductive tubing over the cores 40 mm below the end of the core screen. Shrink each tubing into place by starting on top and continue shrinking them down towards the cable crotch. Allow the tubing to cool before continuing.

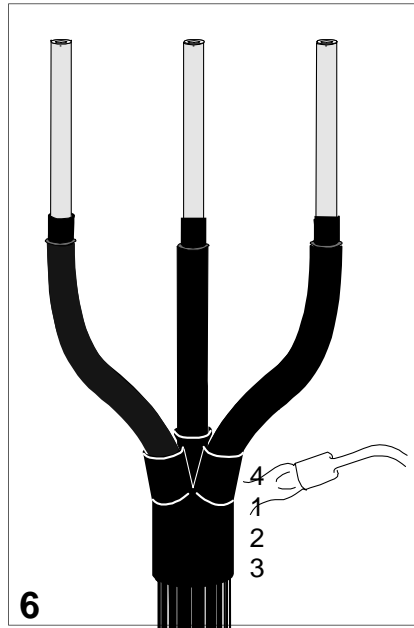

Pull the breakout down the crotch as far as possible. Shrink the breakout into place starting at the centre. Work first towards the lower end and then shrink the turrets onto the cores. The numbers in the drawing indicate the shrinking sequence.

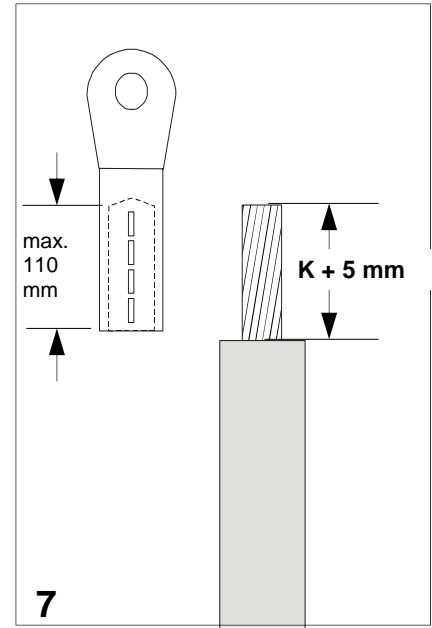

Cut back the insulation according to  **$K = \text{depth of cable lug barrel hole} + 5 \text{ mm}$**  for crimp lug. BLMT = depth of the **cable lug + 0 mm**. Install the cable lug. Remove any sharp edges. Degrease and clean the lug and the insulation using the cleaning tissue provided in the kit. **Note:** Do not use cable lugs with barrel holes deeper than 110 mm.

Remove the release paper and wrap the void filling strip (yellow) around the end of the core screen. Stretch the strip to half of its original width to achieve a fine, thin edge onto the insulation. Cover 20 mm of the core screen and continue onto the insulation for 10 mm.

Apply one complete turn of red sealant mastic (20mm wide) around the barrel of the lugs, at the tab end of the lug barrels as depicted covering the top fastener of compressed area as applicable. Use the remaining sealant to fill in the space between the core insulation and the cable lug to leave a smooth transition.

Preheat the cable lug slightly before placing the tubing over the core so that the top of the tubing covers the crimping area or the top fastener of the cable lug. Shrink the tubing down starting at the screen cut **using a soft yellow flame**. Heat the area well but avoid scorching of surface. Continue shrinking towards the cable lug. Finally shrink down the bottom end of the tubing. The numbers in the drawing indicate the shrinking sequence.

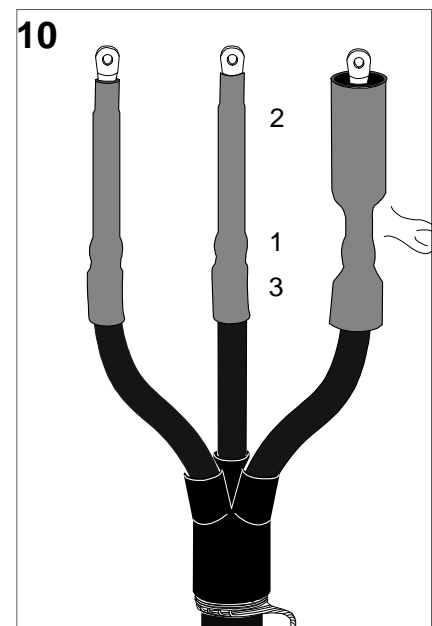
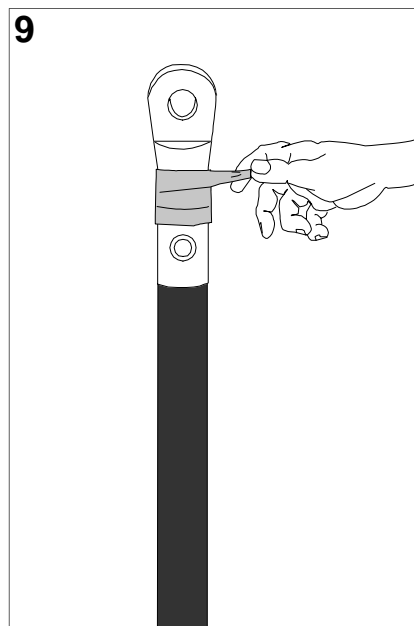
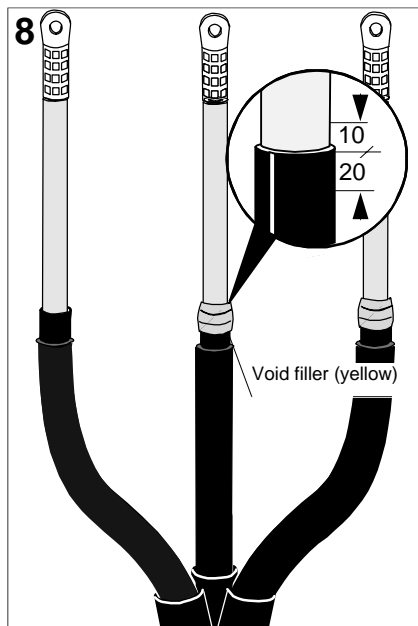

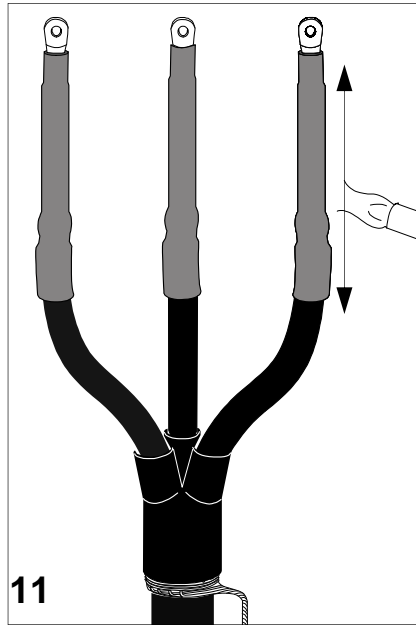

**Indoor termination completed.**

**Note:** After installation the termination must be post-heated as well as the palm of the cable lug until a bead of sealant (green) appears around the top of the tubing.  
Allow the termination to cool before applying any mechanical strain.

Tie the shielding wires or the earth leads with a wire binder to the oversheath below the breakout.  
Gather the shielding wires together to form an earth lead.

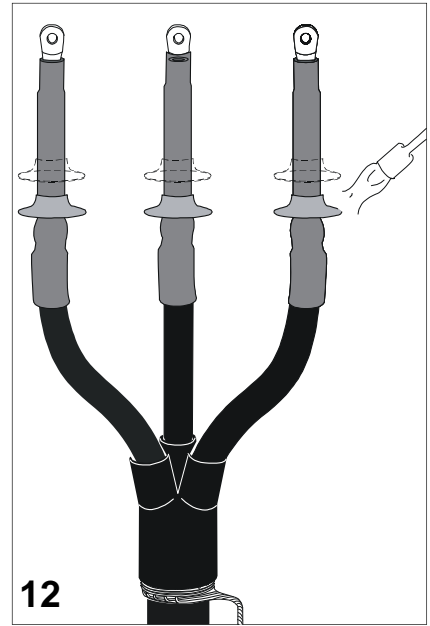

**For outdoor terminations:**

Shrink the skirts into place at the position shown in the drawings on the next page. Start with the first skirt on the lowest position.

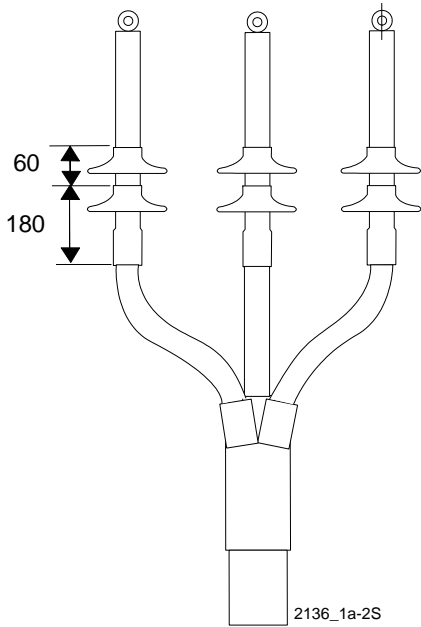

Number of skirts per core		
kV	Indoor	Outdoor
11	0	2

Skirt position for reversed installation

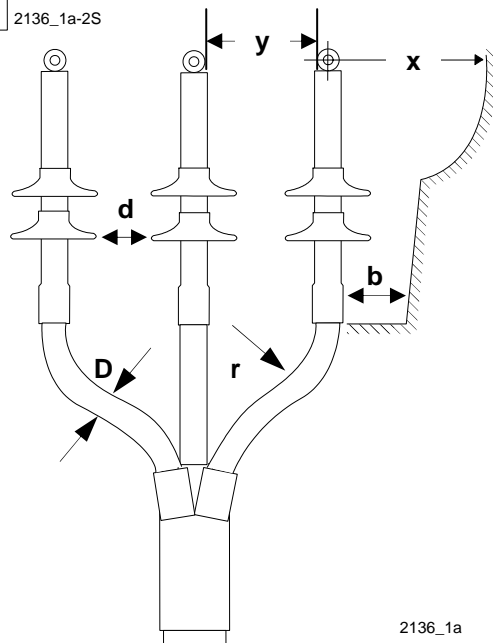
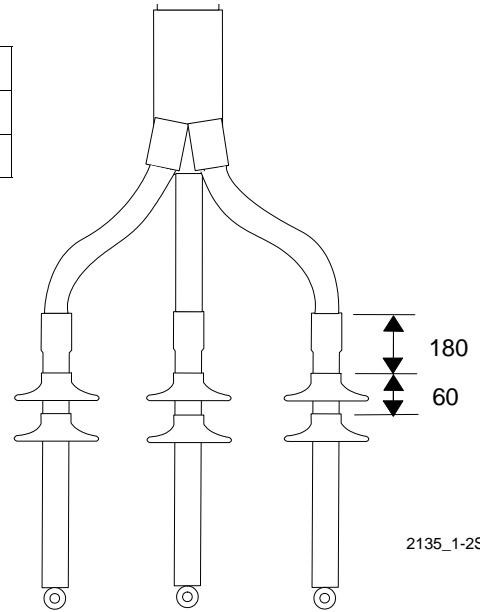

Min. clearances	Max. system voltage in kV
	11
Air clearances	
<b>x</b> ph/ground in mm	160
<b>y</b> ph/ph in mm	185
<b>b</b> ph/ground in mm	15
<b>d</b> Between skirts in mm	10
<b>r</b> (min. bending radius) = 15 x D	

Please dispose of all waste according to environmental regulations.



**Tyco Electronics Raychem GmbH**  
**Energy Division**  
 Finsinger Feld 1  
 85521 Ottobrunn/Germany  
 0049-89-6089-0 tel  
 0049-89-6089-345 fax  
<http://energy.tycoelectronics.com>