

**Installation Instruction
ESD-4872-AU-5/09**

**Straight Through Joint for
11kV Single Core XLPE
Insulated Cables with
Screen Wires and with
Composite Sheath**

35-95mm²

ENDORSED BY	SIGNATURE	DATE
Wilfred Leung Principal Engineer—Mains RailCorp	<i>W. Leung</i>	22. 6. 2009

APPROVED BY	SIGNATURE	DATE
Neal Hook Chief Engineer - Electrical Systems RailCorp	<i>N Hook</i>	19/8/2009

APPROVED BY	SIGNATURE	DATE
Andrew Thompson Product Manager Tyco Electronics	<i>A. Thompson</i>	20/8/09.

MXSU-RCP06

Qty: 1

Kit Contents

1	x	ERIT-35/13-280/U	Screened Insulation Sleeve - 280 Long
2	x	JSCR-26/12-100/U(S1)	Stress Control Tubing - 100 Long
2	x	S1189-1-100(A2)-(C1500)	Void Filling Mastic 20 x 100 Long
1	x	S1300-1-110/110(C1)	Stress Control Patch - 110 x 110
1	x	EPPA-009-5000	Tinned Copper Mesh 5000mm Long
1	x	BSM-25/95	Mechanical Shear Bolt Connector
1	x	EPPA-048-CLAY PACK	Clay Pack
1	x	HEL-4892	Mechanical Shear Bolt Connector (Screen)
1	x	WCSM-70/21-600/S	Thick Wall Insulation Tubing - 600 Long Coated
3	x	EPPA-004	Cleaning Tissue
4	x	S1085-3-150	Sealant Mastic Red - 50 x 150mm Long
4	x	S1085-1-100	Sealant Mastic Red - 20 x 100mm Long
2	x	MWTM-35/12-150/S	Medium Wall Tubing - 150 Long Coated
1	x	EPPA-202-2	PVC Tape - 10 Metres x 25mm Wide
1	x	EPPA-029-3-1000	Tie Wire - 1000 Long
1	x	ESD-4872-AU-4/09	Installation Instruction

Before Starting

Refer to the kit label and the title of the installation instruction to ensure that the kit you are going to use fits the cable.

Components or work steps may have improved since you last installed this product. Carefully read and follow the steps in the installation instruction.

General Instructions

Use an LPG gas torch.

Ensure the torch is always used in a well ventilated area.

Adjust the torch to obtain a soft blue flame with a yellow tip.

Pencil-like blue flames should be avoided.

Keep the torch aimed in the shrink direction to preheat the material.

Keep the flame moving continuously to avoid scorching the material.

Clean and degrease all parts that will come into contact with the adhesive.

If a solvent is used follow the manufacturer's handling instructions.

Tubing should be cut smoothly with a sharp knife leaving no jagged edges.

Start shrinking the tube at the position recommended in the instruction.

Ensure that the tubing is shrunk smoothly all round before continuing along the cable.

Tubing should be smooth and wrinkle free with the inner components clearly defined.

Important:

The joint kit includes cable connectors. RailCorp will not accept substitutes for these connectors unless specific approval has been obtained.

DISCLAIMER

The information contained in these installation instructions is for use only by installers trained to make electrical power installations and is intended to describe the correct method of installation for this product. However, Tyco Electronics has no control over the field conditions which influence product installation.

It is the user's responsibility to determine the suitability of the installation method in the user's field conditions. Tyco Electronics' only obligations are those in Tyco Electronics' standard Conditions of Sale for this product and in no case will Tyco Electronics be liable for any other incidental, indirect or consequential damages arising from the use or misuse of the products.

Raychem is a trade mark of Tyco Electronics.

Cable Overlap

1. Overlap the cables to be jointed as shown.
2. Mark the reference line.

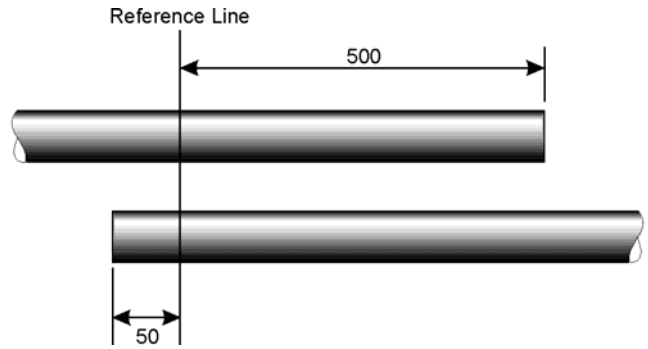

Cable Preparation

- (i) Remove the outer layer of the composite sheath for 215mm, from the reference line. Remove the inner layer of the composite sheath to the dimension shown.
- (ii) Remove the water swellable tapes (if any) level with the inner layer of composite sheath cut.
- (iii) Abrade the outer layer of the composite sheath for a distance of 200 mm from the outer layer composite sheath cut. Abrade the inner layer of the composite sheath.
- (iv) Clean and degrease the inner and outer layer of composite sheath using the cleaning tissue provided in the kit.
- (v) On the side of the joint where the outer sealing sleeve is intended to be parked, clean the outer layer of the composite sheath for a distance of 1 metre using the cleaning tissue provided in the kit.

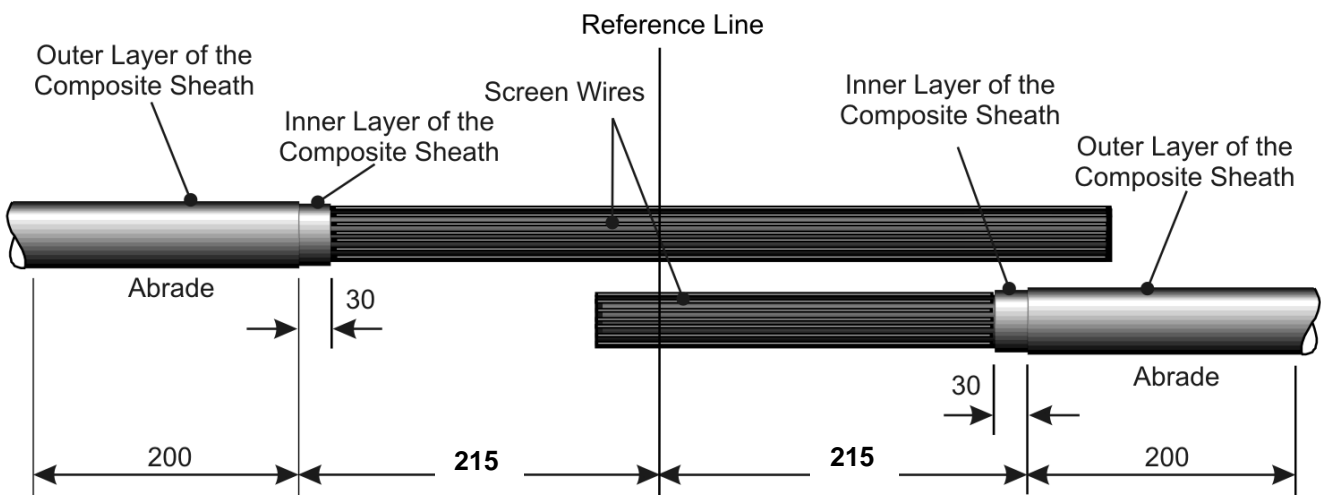

Core Preparation

4. Fold the screen wires back onto the cable sheath. Do not bend them into position at this stage.

Do not cut the cables.

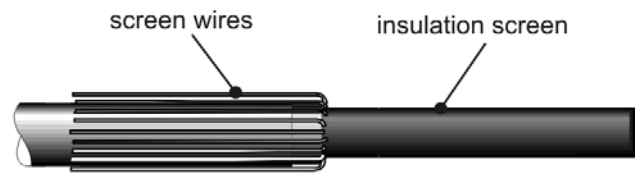

5. Apply one layer of red mastic tape (20mm wide) over the insulation screen, 10 mm from the cable sheath cut.

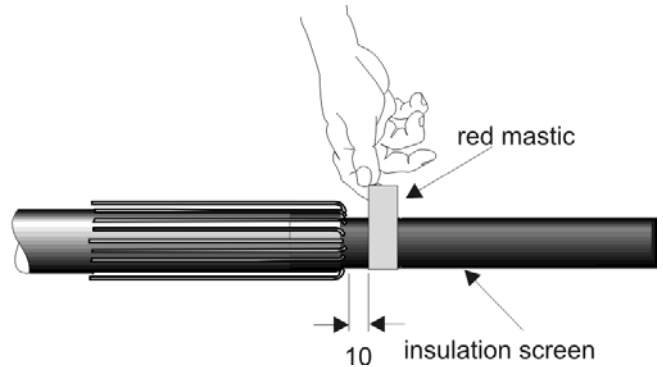

6. Fold the screen wires back over the insulation screen.

7. Apply one layer of red mastic tape (20mm wide) over the screen wires, 10 mm from the cable sheath cut (i.e. over the mastic applied in step 5).

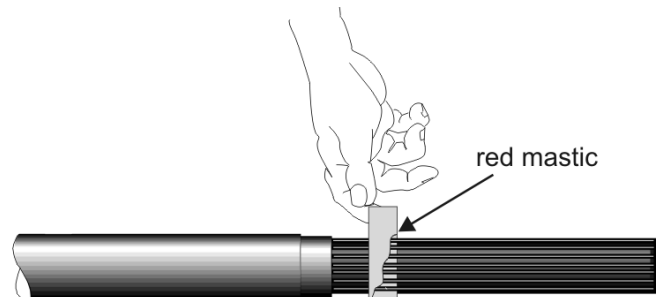

8. Apply red mastic tape (50mm wide) to equally overlap the inner and outer layers of the composite sheath.

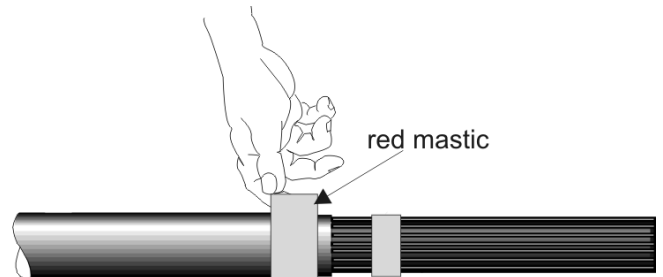

9. Slide the 150 mm long tube (black) over the cable, centered over the outer sheath cutback.

Shrink tube into position, applying additional heat over the area where the red mastic tape was applied.

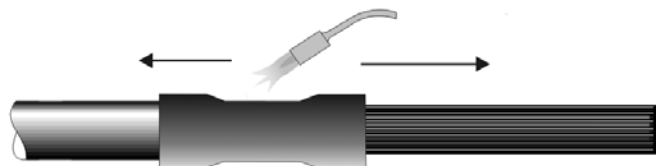

10. Bend the screen wires back over the tube and onto the cable sheath.

Secure the screen wires to the cable using PVC tape.

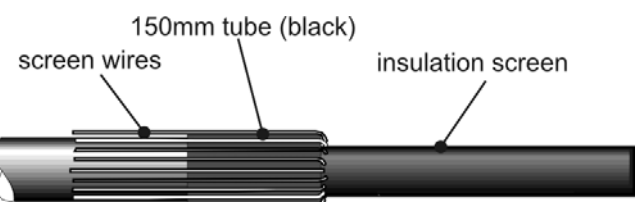

11. Cut the cables at 140mm as shown using a hacksaw or a suitable power driven saw to prevent deformation of the conductor strands.

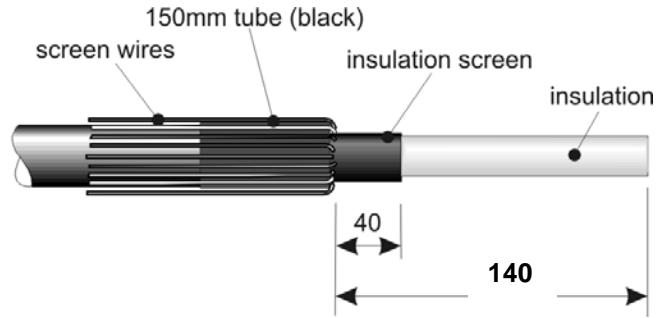

12. Thoroughly remove the insulation screen to the dimension shown, so that the insulation surface is free from all traces of conductive material.

Note: Do not nick the insulation.

13. Remove the insulation from the cables to for a length of 30mm (I)

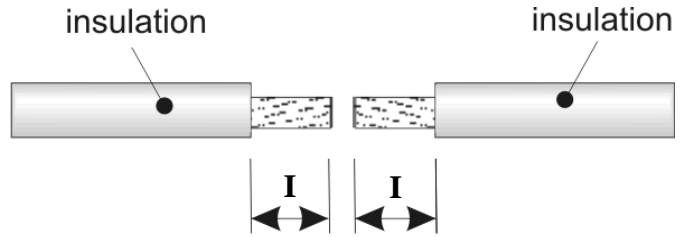

14. Clean and degrease the insulation using the cleaning tissues provided in the kit. Use a wiping action from the exposed conductor towards the insulation screen.

Note: Do not use a cleaning tissue that has previously been in contact with the insulation screen.

15. Remove the yellow void filling tape from the aluminium foil packet.

16. Remove the release papers from the yellow void filling tape with the pointed ends.

Wrap the void filler around the insulation screen starting 20 mm from the end of the insulation screen and continuing onto the insulation for 10 mm. Stretch the tape to half of its original width to achieve a fine, thin edge around the insulation.

Finish on the insulation screen.

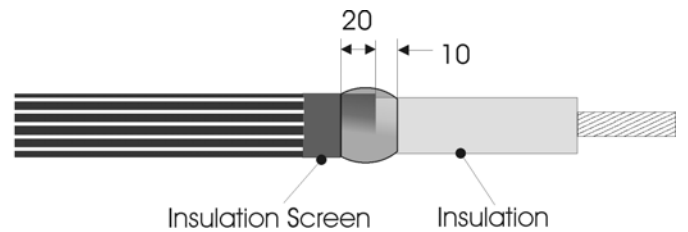

17. Slide the stress control tubing (black) over the cable level with the end of the insulation cut.

Start shrinking from the insulation cut towards the cable sheath as shown.

Apply additional heat over the area where the void filling tape was applied.

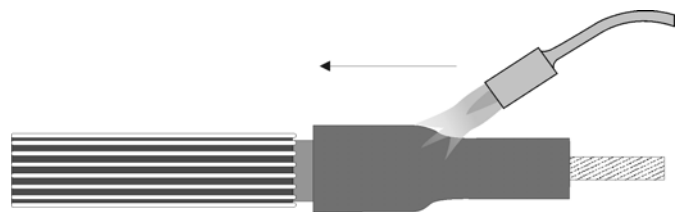

Completion of the Joint

18. Slide a combined tubing set over the cable.

- 1 – Screened insulation sleeve (black and red)
- 2 – Outer sealing sleeve (black)

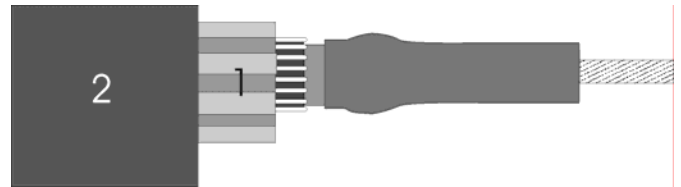

19. The connector is supplied with either half shell inserts or centralising inserts for use on smaller conductor cross sections. Check if each of the conductors will fit with the respective half shell or centralising insert installed. If the conductor fits, leave the half shell or centralising insert fitted. The centralising insert is a tight fit in the connector and requires complete insertion.

If the conductor does not fit with the half shell insert or centralising insert installed, remove and discard the half shell or centralising insert from that side of the connector.

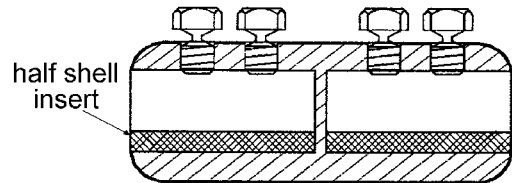

centralising insert

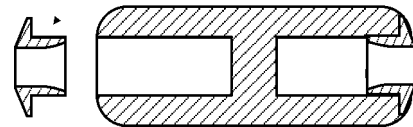

20. Fit the conductors into the connector. There should be no gap left between the connector and the insulation.

Take up the tension equally on all shear bolts with a tee bar spanner (do not shear the heads at this stage).

Starting at the connector ends and working towards the middle (following the number sequence indicated), tighten the bolts until the heads shear off. If a proud edge remains after removal of the bolt heads, this edge should be filed to obtain a smooth finish.

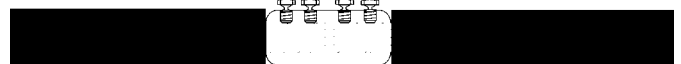
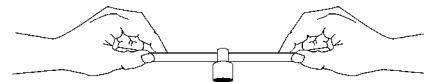

The numbers indicate the bolt tightening sequence.

Note: The use of a support tool (such as Tyco Electronics IT-1000-019) is strongly recommended in order to pick up the torque and avoid conductor bending.

21. Re-align the cables if necessary.

22. Clean and degrease the cable cores and connector using the cleaning tissues provided in the kit.

23. Using the clay pack supplied in the kit, fill the hollows over the sheared off bolts in the connector to obtain a smooth finish.

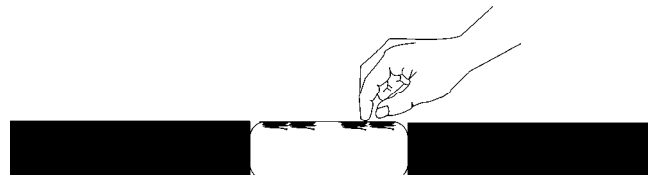

24. Remove the release paper from the stress grading patch (black).

25. Position the patch centrally over the connector area. The start of the patch should just cover the shear bolts to ensure two layers of stress grading will be applied over the shear bolt area.

Note: Apply the long side of the patch across the connector.

26. Wrap the patch over the connector.

Note: Do not stretch the patch.

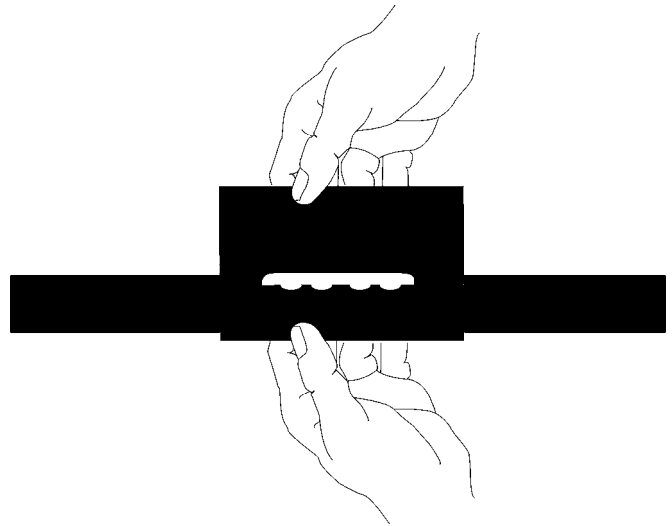

27. Position the screened insulating sleeve (black and red) centrally over the connector area.

a) Start shrinking the sleeves in the centre (1).

b) Continue shrinking by working towards one side (2), stopping 50 mm from the end.

c) Shrink the other half in the same way (3).

d) Shrink down the first end (4) and finally the second (5).

Note: The sleeves should be fully shrunk without leaving ridges.

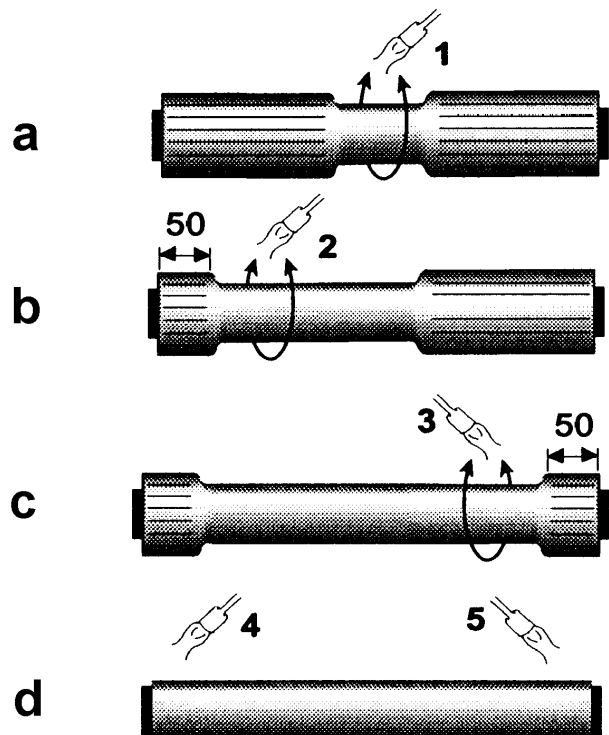

28. Wrap one half-lapped layer of tinned copper mesh around the cable and across the full length of the joint. Cover 80 mm of the 150mm long black tube on the side of the joint with the short screen wires.

Fix the screen wires with a copper wire binder at the end of the tinned copper mesh.

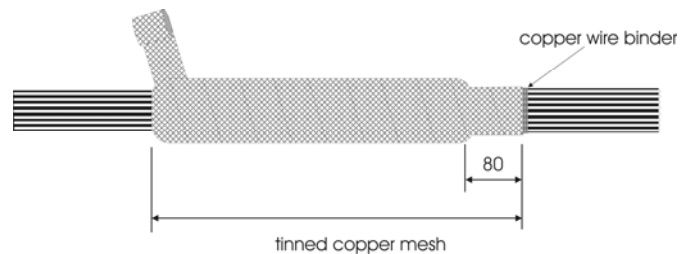

29. **Cable side with long screen wires:**

Bend the screen wires back over the joint area.

30. Cable side with short screen wires:

Bend the screen wires back over the joint area close to the tinned copper mesh. Gather the screen wires together and cut them centrally above the 80 mm tinned copper mesh overlap on the cable sheath.

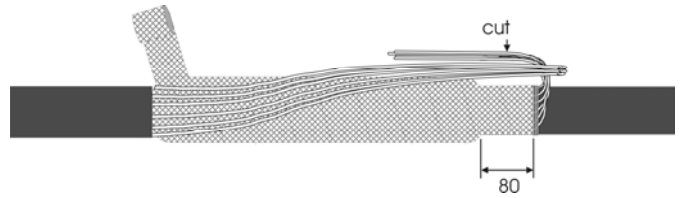

31. Insert the screen wires into the shear head connector supplied.

32. Tighten the shear heads until the heads shear off.

Rotate the screen wire connector so that the screws of the screen wire connector do not puncture the outer sealing sleeve or the screened insulating sleeve.



33. Wrap a second layer of tinned copper mesh around the joint with a 50% overlap. Cover the complete joint area including the mechanical screen wire connector.

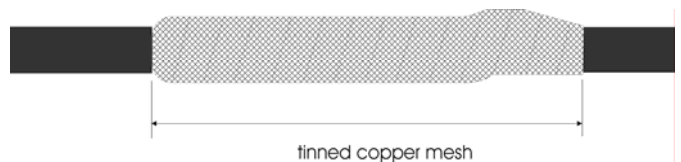

34. Abrade, clean and degrease the cable sheath for a distance of 150mm either side of the tinned copper mesh.

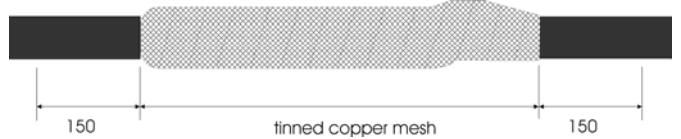

35. Wrap one layer of red sealant tape (50mm wide) around the composite sheath sealing sleeve (Step 9) starting at 20mm from the ends of the mesh on both sides of the joint.



36. Centre the outer sealing sleeve (black) over the copper mesh area.

37. Start shrinking in the centre, working towards the ends.

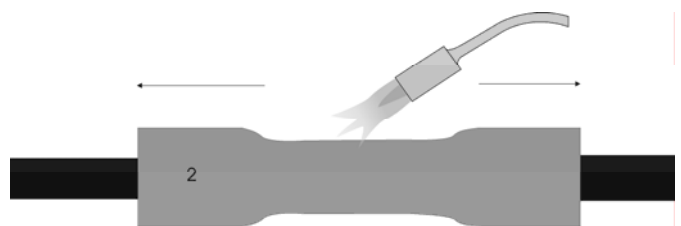

38. The joint is completed.

Allow the joint to cool before applying any mechanical strain.



IMPORTANT NOTE:

YOU MUST ENSURE THAT A BURIED JOINT IS SURROUNDED WITH SOFT BEDDING MATERIAL UP TO A DEPTH OF 100MM ABOVE THE JOINT.

DISCARD THIS INSTRUCTION ONCE THE JOINT IS COMPLETE