

Biodiversity Management Guideline

Protecting and managing
biodiversity on Transport for NSW
projects

March 2024



Acknowledgement of Country

Transport for NSW acknowledges the traditional custodians of the land on which we work and live.

We pay our respects to Elders past and present and celebrate the diversity of Aboriginal people and their ongoing cultures and connections to the lands and waters of NSW.

Many of the transport routes we use today – from rail lines, to roads, to water crossings – follow the traditional Songlines, trade routes and ceremonial paths in Country that our nation’s First Peoples followed for tens of thousands of years.

Transport for NSW is committed to honouring Aboriginal peoples’ cultural and spiritual connections to the land, waters and seas and their rich contribution to society.



Document control

Document owner	Senior Specialist (Biodiversity)
Approved by	Executive Director, Environment and Sustainability
Branch / division	Environment and Sustainability / Safety, Environment and Regulation
Review date	March 2029
Superseded documents	Biodiversity Guidelines: Protecting and Managing Biodiversity on RTA projects (2011)
Front page Photo credit	An exclusion zone (flagging) delineating the boundary of vegetation clearing. Photo: Anthony Arena, TfNSW.

Versions

Version	Date	Amendment notes
1.0	2011	Biodiversity Guidelines: Protecting and Managing Biodiversity on RTA projects 2011.
2.0	2024	Update: EMF-BD-GD-0039 Biodiversity Management Guideline: Protecting and Managing Biodiversity on Transport for NSW projects. Rebranded for Transport for NSW, renamed and updated including: <ul style="list-style-type: none"> • Additional advice on when a Flora and Fauna Management Sub-plan should be prepared as part of a Construction Environmental Management Plan and its contents. • Additions to Guide 1: Pre-clearing process to set out pre-clearing survey and pre-clearing checks. • Additions to Guide 2: Exclusion zones to strengthen tree protection procedures within construction sites. • Additions to Guide 4: Clearing of vegetation and removal of bushrock to provide more information about staged habitat removal. • A major revision to Guide 8: Artificial hollows (previously called Guide 8: Nest boxes) to reflect more recent artificial hollow creation approaches. • Updates to legislation, TfNSW policy and procedures, photos, contacts and references throughout and better cross referencing between Guides.

Related policy and supporting information

- [Transport Biodiversity Policy](#)
- [Transport Environment and Sustainability Policy](#)
- [Environment & Sustainability Management Framework](#)
- [EMF-BD-GD-0012 Microbat Management Guidelines](#)

Contacts and further information



Email: environmentandsustainability@transport.nsw.gov.au

Internal Transport users: [Biodiversity \(SharePoint .com\)](#)

Table of contents

Acronyms and abbreviations.....	5
Definitions.....	5
Licences	10
About this Guideline.....	11
Introduction.....	15
Guide 1: Pre-clearing process	19
Overview.....	26
Guide 2: Exclusion zones	28
Overview.....	39
Guide 3: Re-establishment of native vegetation.....	41
Overview.....	50
Guide 4: Clearing of vegetation and removal of bushrock.....	52
Overview.....	62
Guide 5: Re-use of woody debris and bushrock.....	64
Overview.....	70
Guide 6: Weed management	72
Overview.....	81
Guide 7: Pathogen management.....	83
Overview.....	95
Guide 8: Artificial hollows	96
Overview.....	112
Guide 9: Fauna handling	114
Overview.....	121
Guide 10: Aquatic habitats and riparian zones.....	123
Overview.....	131
References	133

Acronyms and abbreviations

Term	Definition
BC Act	<i>Biodiversity Conservation Act 2016</i>
CEMP	Construction Environmental Management Plan
DCCEEW (Cth)	Department of Climate Change, Energy, the Environment and Water (Cwlth)
DCCEEW (NSW)	NSW Department of Climate Change, Energy, the Environment and Water (formerly the Department of Planning and Environment (DPE))
DPI	NSW Department of Primary Industries
EHG	Environment and Heritage Group, NSW Department of Planning and Environment
EPA	Environment Protection Authority
EPBC Act	<i>Environment Protection and Biodiversity Conservation Act 1999</i> (Cwlth)
EWMS	Environmental Work Method Statement
FFMSP	Flora and Fauna Management Sub-plan
FM Act	<i>Fisheries Management Act 1994</i> (NSW)
LLS	Local Land Services
NATA	National Association of Testing Authorities
TfNSW	Transport for NSW
TPZ	Tree protection zone
WoNS	Weeds of National Significance

Definitions

Term	Definition
Aquatic habitat	Aquatic habitat include all areas of land submerged by water, permanently or intermittently, and include both artificial and natural bodies of water. It includes wetlands, rivers, creeks, lakes, dry river beds and estuaries.
Arborist	A qualified specialist in maintaining trees, e.g. trimming, felling and treatment of disease.
Area of outstanding biodiversity value	An area of land declared to be an area of outstanding biodiversity value (AOBV) in accordance with Part 3 of the <i>Biodiversity Conservation Act 2016</i> . AOBV replaces areas of declared 'critical habitat' under the <i>Threatened Species Conservation Act 1995</i> .
Authorised Representative	See Principal's Authorised Representative.

Berm	A constructed horizontal ledge (e.g. an earth bank, cutting, or mulch) that may be used to delineate areas or stabilise exposed ground.
Biodiversity	The variety of life forms, including flora and fauna, the genes they contain and the ecosystems in which they live.
Biosecurity matter	Any living thing, part of a living thing or product of a living thing (other than a human), or <ul style="list-style-type: none"> • a disease, prion or contaminant, or • a disease agent that can cause disease in a living thing (other than a human) or that can cause disease in a human via transmission from a non-human host (i.e. zoonosis). As defined by <u>Biosecurity Act 2015 Key Terms and Definitions</u>
Blue Book	<u>Managing urban stormwater: Soils and construction, Volume 2D: Main Road Construction</u> (DECC 2008). This is a component of the 4th edition of <u>Managing urban stormwater: Soils and construction, Volume 1</u> (Landcom 2004). Volume 2D should be read in conjunction with Volume 1.
Carbon sequestration	Capture and storage of carbon from the atmosphere e.g. by planting trees that will use atmospheric carbon for growth.
Conditions of approval	Requirements that are placed on a permit or project approval.
Connectivity	Elements of the landscape that permit movement of organisms or genetic flows across the landscape by linking otherwise isolated areas.
Construction footprint	The area directly impacted by construction activities.
Diameter at breast height (DBH)	The nominal trunk diameter at 1.4m above ground level determined from the circumference of the trunk divided by π . See <i>Australian Standard AS 4970-2009 Protection of trees on development sites</i> . (Note: to be consistent with the NSW Biodiversity Assessment Method, TfNSW assessment guidelines use 1.3m above ground level to measure DBH.)
Ecological communities	Are naturally occurring groups of plants and animals. Their species composition can be determined by factors such as soil type, position in the landscape, climate and water availability.
Ecologist	Is a term used by this Guideline to describe the person/s identified in the Construction Environmental Management Plan (CEMP) and any supporting documents as being responsible for supervising/undertaking activities that require specialist ecological expertise. The Ecologist should have tertiary qualifications in science or a related discipline, a minimum of 3 years relevant experience and be covered by a scientific licence.
Environment Manager	Is a term used by this Guideline to describe the person/s responsible under the construction contract for ensuring the Construction Environmental Management Plan (CEMP) is established, implemented, and maintained including all sub-plans, procedures and supplementary Environmental Work Method Statements.

	Under G36 specification this person can be either the Environmental Management Representative and/or the Environmental Site Representative .
Environmental Site Representative	<p>Is the authorised contact person for communications with the Principal and relevant regulatory authorities on all environmental matters.</p> <p>Under Section 3.3 of the G36 specification, the Environmental Site Representative must have tertiary qualification in Environmental Science, Environmental Engineering or equivalent, and a minimum of 5 years' experience in environmental management on road construction or other equivalent works.</p>
Fauna	All animals
Flora	All plants
Fragmentation	Describes the result of removal (usually by clearing) of large parts of a natural area, resulting in the retention of only small parts (fragments or remnants) of habitat.
Glider poles	Wooden poles installed to assist gliding animal species (such as squirrel gliders) to cross roads. Animals glide between poles as they would between trees.
Ground cover	A low growing woody or herbaceous plant.
Grubbing	Digging or grinding for the purpose of removing stumps, roots and other sub-surface vegetative material.
Habitat	An area or areas occupied, or periodically or occasionally occupied, by a species or ecological community, including any biotic or abiotic component. <u>Biodiversity Assessment Method</u>
Hydromulching	Broadcast spraying of mulch, binder and green dye. Seed is sometimes added.
Hydroseeding	Broadcast spraying of seed under pressure by spraying a slurry of water, seed and fertiliser.
Identified habitat	Habitat (e.g. hollow-bearing trees, bushrock, feed trees) that has been identified by an Ecologist during the environmental assessment or pre-clearing process that requires mitigation e.g. exclusion fencing.
Key Threatening Processes	Processes listed under the <i>Biodiversity Conservation Act 2016</i> or the <i>Environment Protection and Biodiversity Conservation Act 1999</i> (Cwlth) that adversely affect threatened species, or ecological communities, or that could cause species, or ecological communities to become threatened.
Local provenance	Plants whose native origin is close to where they are going to be planted (for example in the same local area).
Marine vegetation	Mangroves, seagrasses or any other species of plant that at any time in its lifecycle must inhabit water (other than freshwater)
Median	The central reservation which separates carriageways from traffic travelling in the opposite direction. This can be vegetated or non-vegetated.

Microbat	A small, insect-eating, flying mammal.
Microclimates	The climate of a localised area (e.g. under a log) with environmental conditions such as humidity and temperature that may differ to the surrounding area.
Mulch	Shredded vegetation used for soil stabilisation and moisture conservation. For the legal definition of mulch see EPA Resource Recovery Order relating to mulch
Offset	Measures carried out offsite that aim to replace biodiversity values lost on a site by damaging or removing all or part of an ecosystem or habitat.
Pathogens	Bacteria, viruses or fungi that can cause disease.
Pest	Animal and plant species that are considered damaging to the environment, agriculture or health.
Principal's Authorised Representative	Is the Transport person that must be reported to in the case of specific incidents, events, situations, or milestones under the Construction Environmental Management Plan (CEMP). Shortened to Authorised Representative in this Guideline.
Priority weed species	Are identified in the relevant regional strategic weed management plan and includes NSW and regional priority weed species and the general biosecurity duty relating to them.
Project arborist	The person responsible for carrying out the tree assessment, report preparation, consultation with designers, specifying tree protection measures, monitoring and certification. The project arborist will be suitably experienced and competent in arboriculture, having acquired through training. Qualification (minimum Australian Qualification Framework (AQF) Level 5, Diploma of Horticulture (Arboriculture) and/or equivalent experience, the knowledge and skills enabling that person to perform the tasks required by the <i>Australian Standard AS 4970-2009 Protection of trees on development sites</i> .
Protected animal	An animal of a species referred to in Schedule 5 of the <i>Biodiversity Conservation Act 2016</i> .
Protected plant	A plant of a species referred to in Schedule 6 of the <i>Biodiversity Conservation Act 2016</i> .
Ramsar	An intergovernmental treaty which provides the framework for national action and international cooperation for the conservation and wise use of wetlands and their resources.
Re-snagging	Replacement of wood snags (large woody debris) in a waterway.
Riparian zone	The area of land alongside an aquatic habitat. See definition of Aquatic habitat.
Rootball	The main mass of roots and soil at the base of a tree or shrub.
Rope canopy bridge	Rope structures installed over roads that assist animals that live in trees (such as possums) to cross areas that are barriers to their movement (e.g. roads). Animals climb on the rope as they would on the branches of trees.

Shrub	A woody perennial plant (smaller than a tree) that usually has several stems arising at or near the ground giving the plant a bushy appearance. If uncertain refer to <u>Bionet Native Species by Growth Form data</u> .
Snag	Large woody debris from trees and shrubs, including whole fallen trees, broken branches and exposed roots that have fallen or washed into a waterway and are now wholly or partially submerged by water.
Soil compaction	The compression of soil such that air and water is pushed out of the spaces between soil particles making it denser. This may occur from driving heavy machinery over the soil for example.
Species	A level of biological classification comprising one or more populations of individuals capable of interbreeding to produce fertile offspring.
Staged habitat removal	Removal of habitat in stages where specific habitat features are identified by pre-clearing surveys. For example, the removal of non-habitat vegetation first (e.g. shrubs), leaving the remaining marked habitat for at least 24 hours, then removing that habitat (e.g. hollow bearing trees) under the supervision of an ecologist. Staged habitat removal reduces the potential impacts of clearing and associated activities on fauna.
Statement of commitments	Details of additional actions or measures that will be carried out as part of a project.
Stockpile	The temporary storage of material or plant for construction projects.
Terrestrial	Refers to environments other than aquatic or marine environments. It includes subterranean environments.
Threatened ecological communities	Collective term referring to critically endangered, endangered or vulnerable ecological communities listed under the <i>Environment Protection and Biodiversity Conservation Act 1999</i> (Cwlth) and/or the <i>Biodiversity Conservation Act 2016</i> (NSW).
Threatened species	Collective term referring to critically endangered, endangered or vulnerable species listed under the <i>Environment Protection and Biodiversity Conservation Act 1999</i> (Cwlth) or the <i>Biodiversity Conservation Act 2016</i> (NSW)
Torpor	A period of inactivity and temporary hibernation for fauna.
Tree	A tree for the purpose of this Guideline is a long-lived perennial plant greater than 3 m in height with one or relatively few main stems or trunks. If uncertain, refer to <u>Bionet Native Species by Growth Form data</u> .
Tree protection zone	The tree protection zone (TPZ) is a specified area above and below ground and at a given distance from the trunk set aside for the protection of the tree's roots and crown to provide for the viability and stability of a tree to be retained where it is potentially subject to damage by development.
Tributary	A creek or river that flows into a larger creek or river.
Weed	A plant that requires some form of action to reduce its effects on the economy, the environment, human health and/or amenity. See to Table 6.1 for further information on the classification of weeds in NSW.

Wildlife crossing zone	An area with several constructed or designed features that assist animals to cross roads safely e.g. rope canopy bridges, vegetation, underpasses. This may include structures not intentionally designed for fauna passage though have become (or have potential to become) a wildlife crossing zone (e.g., bridges and culverts designed for drainage).
------------------------	---

Licences

The table lists the *Biodiversity Conservation Act 2016* licences that may apply to activities in this Biodiversity Management Guideline.

Activity	Licence
Fauna handling	<u>Catch and release licence</u> or <u>Scientific licence</u>
Wildlife rehabilitation (carer)	<u>Rehabilitating injured, sick or orphaned native animals</u>
Control or harm native & threatened animals	<u>Licences to control or harm native animals</u>
Native seed collection	<u>Scientific licence</u> (seed collection)
Pre-clearing survey and checks	<u>Scientific licence</u> (ecological survey or consultancy)
Pesticide and herbicide application	<u>Ground applicator licence</u>

About this Guideline

Purpose

The Biodiversity Management Guideline (this Guideline) provides advice on the practical actions required to minimise and mitigate impacts on biodiversity during infrastructure construction activities. It is expected that the strategies set out in this Guideline will be integrated into all the following:

- Construction Environmental Management Plans (CEMP) including sub-plans relating to flora and fauna, e.g. Flora and Fauna Management Sub-plan (FFMSP).
- Environmental Work Method Statements (EWMS).
- Contract specifications.

While not explicitly designed for this purpose, this Guideline may also inform the routine management and maintenance of Transport infrastructure, including exempt development.

Transport welcomes informed innovation and well justified deviations from this Guideline acknowledging that there are knowledge gaps in our understanding of effective biodiversity mitigation and that there can be a range of mitigation options to address key risks.

Biodiversity and linear infrastructure corridors

Biodiversity is the variety of life forms, including flora and fauna and the genes they contain and the ecosystems in which they live. Australian ecosystems contain many species found nowhere else in the world.

There are over 220,000 kilometres of public roads in NSW including over 40,000 kilometres of State and Regional roads and over 180,000 kilometres of local roads. Many roads, particularly in rural areas, exist within a 'roadside reserve' which provides a buffer between the road and neighbouring lands. 'Road reserves' cover approximately 1 million hectares, of which about 50 per cent contains native vegetation.

There are also over 10,000 kilometres of rail lines in NSW including active and inactive freight lines and sidings, Light rail, railways and Sydney Metro. Like road reserves, remnant vegetation can be found in some rail reserves which cover approximately 55,000 hectares, of which about 42 per cent contains native vegetation.

Linear infrastructure corridors, including road and rail reserves, often contain important biodiversity that is rare in the surrounding landscape and can provide the habitat connectivity needed to maintain viable habitats overtime.

Policy context

The Transport Biodiversity Policy commits Transport to protect and enhance biodiversity with the goal of achieving no net loss of biodiversity as a consequence of its infrastructure development activities. The Biodiversity Policy is grounded in the following key principles.

To achieve no net loss, Transport will:

- Apply the ‘avoid, minimise, mitigate and offset’ hierarchy to all Transport infrastructure, through all stages of the infrastructure development lifecycle.
- Provide biodiversity offsets or conservation measures for all Transport development activities where it is feasible and reasonable to do so, including where the impacts do not trigger the legal offset requirements.
- Work with communities to deliver transparent, scientifically robust, conservation outcomes and improved opportunities to care for Country.
- Support a robust credit market and an equitable and transparent approach to credit sourcing and pricing.
- Maximise opportunities to improve the financial sustainability of biodiversity offsets.

The Transport Biodiversity Policy applies to all Transport cluster agencies including TfNSW, Sydney Metro, NSW Trains and Sydney Trains with specific commitments to provide biodiversity offsets and other conservation measures applying to TfNSW only.

This Guideline is a key mechanism to implementing the first principle of avoiding, minimising and mitigating biodiversity impacts as part of the construction process. For context, as to how this Guideline relates to other Transport biodiversity related documents, see the Biodiversity Guidelines library on the Transport internal SharePoint site called Environment and Sustainability Source.



Figure (i): Cryptic species such as this threatened Stephens Banded Snake (*Hoplocephalus stephensii*) can occur in habitats within and adjacent to project impact areas (Photo: Brenton Hays).

Who should use this Guideline

People with responsibility for meeting environmental requirements under a Transport construction contract should refer to this Guideline when designing and implementing mitigation measures for biodiversity as part of an infrastructure development project.

People with this responsibility would include:

Environment Manager: is a term used by this Guideline to describe the person/s responsible under the construction contract for ensuring the Construction Environmental Management Plan (CEMP) is established, implemented, and maintained including all sub-plans, procedures and supplementary Environmental Work Method Statements. Under the G36 specification this person can be either the **Environmental Management Representative** and/or the **Environmental Site Representative**.

Environmental Site Representative: is the authorised contact person for communications with the Principal and relevant regulatory authorities on all environmental matters as per the G36 specification.

Ecologist: the person/s identified in the CEMP and any supporting documents as being responsible for supervising/undertaking activities that require specialist ecological expertise.

Authorised Representative: the Transport person that must be reported to in the case of specific incidents, events, situations, or milestones under the CEMP. Referred to as the **Principal's Authorised Representative** in the G36 specification.

While this Guideline is intended for the construction of new infrastructure development projects, Transport staff may also find components of this Guideline useful in informing environmental management practices during the delivery of maintenance and other operational activities.



Figure (ii): Clearing native vegetation has the potential to cause unintended impact on biodiversity. When clearing native vegetation, refer [Guide 4: Clearing of vegetation and removal of bushrock](#) (Photo: Anthony Arena, TfNSW).

Structure of this Guideline

The Introduction outlines the strategic setting, objectives and purpose of this Guideline.

This Guideline contains ten individual Guides (Table (i)) that cover specific aspects of biodiversity management during construction. Within the Guides, relevant information is grouped so it can be easily accessed as required. In cases where specific content with the Guides needs to be read in conjunction with other Guides, a cross reference is included. At the end of each Guide there is an overview of its key features.

Table (i) provides a quick reference to each Guide and an outline of information it covers.

Table (i): Biodiversity Management Guideline – quick reference to Guides.

Guide	Outline
Guide 1: Pre-clearing process	Guidance for the pre-clearing process that should be conducted before any clearing takes place to minimise the impact on native flora and fauna.
Guide 2: Exclusion zones	Guidance for determining and establishing exclusion zones to prevent damage to native vegetation and fauna habitats and prevent the distribution of pests, weeds and disease.
Guide 3: Re-establishment of native vegetation	Guidance for the re-establishment of native vegetation through managing site conditions, material sourcing and procurement, and seed and plant stock installation and establishment.
Guide 4: Clearing of vegetation and removal of bushrock	Guidance for minimising the impact of habitat removal, such as vegetation clearing and bushrock removal, on native flora and fauna.
Guide 5: Re-use of woody debris and bushrock	Guidance for maximising the re-use of woody debris and bushrock to minimise loss and/or damage to native flora and fauna habitats.
Guide 6: Weed management	Guidance for preventing or minimising the spread of priority weed species on all TfNSW project sites.
Guide 7: Pathogen management	Guidance for preventing the introduction and/or spread of disease-causing agents such as bacteria and fungi.
Guide 8: Artificial hollows	Guidance for minimising the impact of hollow loss by providing supplementary fauna habitat in the form of artificial hollows (nest boxes, carved hollows, salvaged hollows).
Guide 9: Fauna handling	Guidance for minimising impacts on fauna as a result of being handled by humans and preventing injury to people handling fauna.
Guide 10: Aquatic habitats and riparian zones	Guidance for limiting impacts on aquatic flora and fauna and their habitats, and to maintain fish movement during works in a waterway.

Introduction

Impacts of TfNSW projects on biodiversity

Infrastructure reserves retain significant biodiversity values that can be rare in the surrounding landscape. Road and rail development projects are often undertaken within existing reserves such as a road widening or intersection improvement project. They can also involve new infrastructure incursions into 'greenfield' sites such as new rail lines or road bypass and duplication projects.

It is important that the potential impact on biodiversity of new infrastructure development is considered, and steps taken to avoid, minimise, mitigate and if necessary, offset these impacts. TfNSW is responsible for new infrastructure development on all state and regional roads in NSW and certain new rail development, with local government being responsible for local roads. As such, TfNSW is well positioned to make a significant contribution to the conservation of biodiversity within linear infrastructure reserves.

The types of impacts to biodiversity that could typically occur during construction projects are:

- Loss of native vegetation, potentially including threatened species and ecological communities.
- Loss of habitat for native flora and fauna.
- Direct mortality of native fauna.
- Loss of connectivity for flora and fauna.
- Loss of foraging and nesting resources for fauna.
- Fragmentation of vegetation resulting in edge effects, isolation and barrier effects.
- Disturbance effects from noise, light and wind turbulence.
- Water quality changes due to works in or adjacent to aquatic habitats and alterations to flow.
- Invasion and spread of weeds and pest fauna species.
- Spread of pathogens.

Trees, both native and exotic, can be highly valued by people due to their beauty, function, historical, ecological or cultural significance. Examples of this include rows of trees planted to commemorate fallen soldiers, visually prominent trees that provide local landmarks, shade trees that mitigate the heat island effect of urban areas, trees that have cultural values for Aboriginal people such as scar trees, bush food, medicine plants and other resources, or the important and universal ability of any tree to capture and sequester carbon.



Figure (iii): Projects can have potential impacts on biodiversity including amphibian species such as the threatened Sloane's Froglet (*Crinia sloanei*) near Hume Highway, Albury (Photo: David Hunter, DPE).

Planning for biodiversity management

The success of biodiversity management during projects depends strongly on carefully planning the works. Proper and thorough planning and design at the earliest stages of the project allows the **Environment Manager** to foresee any logistical or timing issues. This early intervention is essential for avoiding or minimising impacts to biodiversity as it will allow enough time for biodiversity impacts to be considered adequately and to gather required resources. Figure (iv) provides an overview for planning and implementing biodiversity management measures.

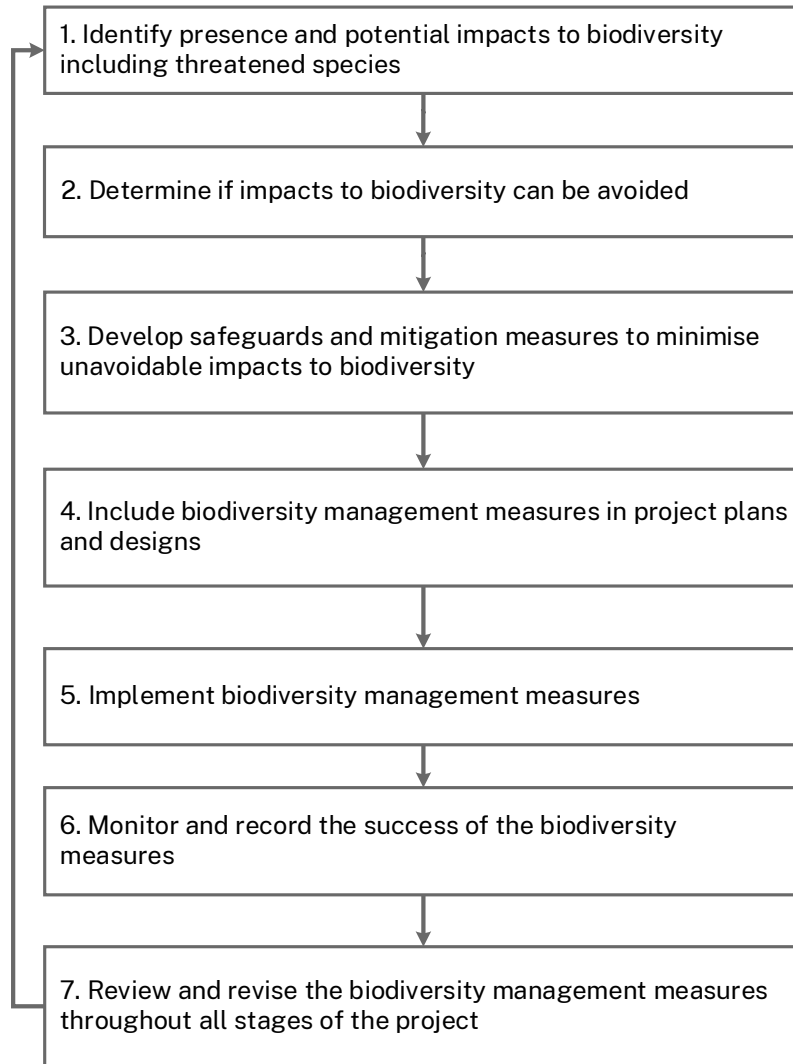

Figure (iv): Planning and implementing biodiversity management measures for infrastructure projects.

In some cases, timing is an essential consideration for appropriate mitigation. In these cases, early planning for biodiversity management may prevent additional costs to the project. For example, some fauna breeding season requirements may dictate the timing of clearing and could delay the project if not identified and accounted for at the planning stage.

Modifications to the project are required to be consistent with any conditions of approval, environmental safeguards, statement of commitments and legislation. Additional impacts to biodiversity must be adequately assessed.

The environment impact assessment undertaken for the project and the mitigation measures set out in the conditions of approval or project determination are important starting points for all construction planning.

Consider the following during the earliest stages of construction planning for a project:

- Threatened flora and fauna species and ecological communities that may be impacted and options to avoid.
- Opportunities to create and/or maintain habitat connectivity and to minimise ongoing vehicle strikes and wildlife injury during construction.
- Integration of biodiversity mitigation within landscaping plans.
- The need for resources such as Ecologists, licensed handlers, special equipment or materials.
- The timing of expected environmental impacts given the lifecycle of potentially impacted animals (e.g. breeding, birthing, torpor or wet/dry seasons).
- Clearly outlining in contract and tender documents, roles and responsibilities for biodiversity management measures.
- The use of environmental management plans and operational procedures to manage impacts on site and reduce the risk of environmental harm. This would include the timing, implementation methods, and monitoring and review process.

When a Flora and Fauna Management Sub-plan should be prepared

The **Environment Manager** should, in addition to any requirements of a condition of approval, consider the preparation of a Flora and Fauna Management Sub-plan (FFMSP) as part of the CEMP when:

- Native vegetation or amenity trees are being cleared or impacted by the project.
- Threatened species occur or have the potential to occur in the area.
- Fauna habitat features (e.g. hollow-bearing trees or bushrock) are being removed, re-used or relocated.
- Re-establishment of native vegetation is required.
- Pathogens are known to occur in the area.
- Artificial hollows have been recommended to mitigate natural hollow loss.
- Works are being carried out in aquatic habitats or riparian zones.
- Groundwater drawdown (even temporarily) is proposed near ground-dependent ecosystems.
- Work is in/near a mapped coastal wetland or littoral rainforest (Resilience and Hazards SEPP).
- A weed management plan or program should be prepared and implemented.
- Standard approaches to the identification of Tree Protection Zones (TPZ) cannot be applied or where incursions to a TPZ are unavoidable.

When a specialist is required

This Guideline does not replace the need for specialist input. Specialist input requirements should be identified in the CEMP and/or the FFMSP.

Specialist input may be required during any phase of a project.

Each Guide in this Guideline outlines when specialist advice is recommended. **All references to specialists are highlighted in bold.**



Figure (v): Infrastructure projects can intersect with sensitive environments, such as the new bridge over the Clarence River built as part of the Woolgoolga to Ballina Pacific Highway Upgrade Project (Photo: TfNSW).

Guide 1: Pre-clearing process

Background

The ecological 'pre-clearing surveys' and 'pre-clearing checks' are important steps in the pre-clearing process to mitigate impacts on native flora and fauna species. These impacts could include clearing of threatened flora or fauna species that may have moved into the area since previous surveys. This is particularly important where the season or prevailing weather conditions influence whether a species is found in an area.

Clearing associated with construction results in loss of vegetation and fauna habitat. Impacts on native flora and fauna, including threatened species, are minimised by:

- Conducting an ecological pre-clearing survey and pre-clearing checks.
- Implementing staged habitat removal (see [Guide 4: Clearing of vegetation and removal of bushrock](#)).

The pre-clearing process can also be used to confirm trees and hollows that require replacement in accordance with the TfNSW [EMF-BD-GD-0129 Tree and Hollow Replacement Guideline](#).

The pre-clearing process should be documented in the Flora and Fauna Management Sub-plan (FFMSP) under the Construction Environmental Management Plan (CEMP). This documented information is guided by information gathered during biodiversity surveys conducted in the environmental assessment phase of the project (e.g. location of fauna habitat features).



Figure 1.1: Termite mounds can be excavated for nesting by hollow-dependent species, such as Kookaburras and Kingfishers, and may contain other species at the time of clearing (Photo: Brenton Hays, TfNSW).

Objective

The objective of this Guide is to outline the pre-clearing process to minimise the impact on native flora and fauna including those with value to Aboriginal people.

Application of this Guide

This Guide is applicable where all or some of the following conditions are met:

- Threatened flora populations, threatened fauna and/or a threatened ecological community (TEC) has been identified to occur or potentially occur in the area during the environmental assessment process.
- Hollow-bearing trees, including standing dead trees with hollows are to be removed.
- Native or non-native vegetation that is likely to provide habitat for resident native fauna.
- Bushrock is to be removed.
- Potential roosting habitat for microbats (e.g. in bridges or culverts) is to be disturbed or removed.



Figure 1.2: The pre-clearing process should provide information on the presence of fauna habitat such as this glider feed tree showing recent signs of feeding (Photo: Brenton Hays, TfNSW).

Specialist input requirements

Use qualified **Ecologists** with experience in fauna survey and handling to conduct flora and fauna searches and obtain their input when identifying potential fauna release sites.

Where artificial hollows are being provided, address the requirements of [Guide 8: Artificial hollows](#).

Use a **licensed wildlife carer** or ecologist to carry out any fauna handling in accordance with [Guide 9: Fauna handling](#).

Management requirements

The FFMSPP should include a pre-clearing process that:

- Is based on a review of the biodiversity assessment undertaken as part of the environmental impact assessment to identify known locations of biodiversity features. This may include threatened flora and fauna (and their habitat) and threatened ecological communities that need to be considered during the pre-clearing process.
- Requires ecological pre-clearing survey at least one week prior to clearing of vegetation with habitat value followed by a final pre-clearing check 24 hours prior to clearing operations. Surveys should be repeated should clearing be delayed for longer than one week (e.g. due to rain). See sections below: [Pre-clearing survey](#) and [Final pre-clearing checks](#).

- Considers whether a staged program of clearing is required. See [Guide 4: Clearing of vegetation and removal of bushrock](#).
- Determines whether artificial hollows are to be deployed as part of pre-clearing surveys and details how they are to be deployed. See [Guide 8: Artificial hollows](#).
- Requires that the number and size of trees and tree hollows to be cleared be determined in accordance with TfNSW Tree and Hollow Replacement Guidelines if required by the project.
- Applies all necessary measures including erosion and sediment controls, and directional felling to protect aquatic habitat and riparian zones. See [Guide 10: Aquatic habitats and riparian zones](#).
- Requires that any person handling fauna must hold appropriate licence/s under the Biodiversity Conservation Act 2016 (see [Licences](#)).
- Includes an unexpected threatened species finds procedure which outlines the actions required upon any discovery of a threatened species or threatened ecological community not assessed by the biodiversity assessment (see template below). An unexpected animal onsite protocol may also be required for certain projects. See [Guide 9: Fauna handling](#).
- Requires that an Ecologist identify suitable release sites for any native fauna found during clearing operations. Such habitat must be identified on a map.
- Supports third party requests to salvage plants, plant parts or seeds prior to clearing.
- Is based on a review of any site weed assessment and weed management plan prepared for the project. See [Guide 6: Weed management](#) and makes provision for clearing from least to most weed impacted areas.
- Applies any necessary machinery, plant and equipment hygiene protocols to minimise the spread of weeds, pests and diseases. See [Guide 7: Pathogen management](#).
- Is informed by any Aboriginal cultural heritage surveys undertaken for scar trees or any another natural features of Aboriginal cultural heritage significance.
- Includes reporting to the Authorised Representative and Environment Manager. See sections below: [Pre-clearing survey](#) and [Final pre-clearing checks](#).



Figure 1.3: This hollow-bearing stag is an example of a habitat tree that would be identified during pre-clearing surveys (Photo: Brenton Hays, TfNSW)

Pre-clearing survey

In undertaking the pre-clearing survey at least one week prior to clearing, the **Ecologist** should:

- a) Confirm the locations of biodiversity features identified in the environmental assessment, including delineating the boundary of threatened ecological communities (TECs) as

appropriate and any clearing limits prescribed in any approval conditions/environmental safeguards.

- b) Identify any fauna that have the potential to be disturbed, injured or killed as a result of clearing activities (e.g. nesting birds, native bees).
- c) Check for the presence of threatened flora and fauna species that were identified in the environmental assessment as likely to occur. This check should be: undertaken during optimal weather conditions, season and time of day/night for identifying targeted flora and fauna species.
- d) Record the details of all hollow-bearing trees and/or trees/other habitat features containing threatened fauna and threatened flora, unless information is already available (check information obtained during the biodiversity assessment, Artificial Hollow Strategy and/or Tree and Hollow Replacement Plan). Details to be collected (where applicable) include GPS location, tree species, type of habitat feature (e.g. nest, hive, bushrock), estimate diameter of hollow entrance (e.g. <5cm, 5-10cm, 10-30cm, >30cm), and type of hollows (e.g. branch, limb, trunk).



Figure 1.4: Habitat tree flagged and marked with unique ID during pre-clearing survey for the Coffs Harbour Bypass Project (Photo: Sandpiper Ecological Surveys).



Figure 1.5: An ecologist surveying for habitat trees during the pre-clearing process for the M1 Pacific Motorway extension to Raymond Terrace Project (Photo: Brad Whittard, TfNSW).

- e) Mark habitat features to be protected during construction. Use suitable methods (e.g. flagging tape and/or spray paint) to mark:
 - All hollow-bearing trees or habitat features.
 - Any trees found to contain threatened fauna.
 - The location of any threatened flora.
- f) Make recommendations to reduce impacts on flora and fauna including staged habitat removal, sequencing, timing or clearing methods. This may include installation of measures to exclude access to habitat features (e.g. tree guard to prevent climbing animals from accessing – see Figure 1.5).

- g) Confirm the location of pre-determined habitat identified for the release of any fauna encountered on site.
- h) Submit any updated maps/plans, pre-determined habitat for the release of fauna, habitat features and recommended clearing procedures to the **Environment Manager** as required.
- i) Repeat surveys should clearing be delayed for longer than one week (e.g. due to rain).

The results of the pre-clearing survey should be documented in a pre-clearing report prepared by the **Ecologist** and submitted to the **Environment Manager** and **Authorised Representative** prior to the commencement of clearing.

Final pre-clearing checks

Final pre-clearing checks should be undertaken no more than 24 hours prior to clearing commencing. Projects requiring multiple days of clearing should consider having pre-clearing checks conducted daily so that checks are undertaken close to clearing.

Emerging fauna survey techniques such as drone surveys can be utilized for pre-clearing inspections for species capable of detection using this technique (e.g. koala). They require careful planning, trained practitioners and appropriate authorisations.

The **licensed handler** or **Ecologist** should check that:

- a) Exclusion zones are appropriately fenced and signage is in place. See Guide 2: Exclusion zones.
- b) Habitat trees have been marked for staged clearing. See Guide 4: Clearing of vegetation and removal of bushrock.
- c) Any other biodiversity-specific management measures are established as required.
- d) Fauna that has the potential to be disturbed, injured or killed as a result of clearing activities are captured and/or relocated into pre-determined habitat identified for fauna release. See Guide 9: Fauna handling.
- e) Any additional recommendations to the **Environment Manager** and **Authorised Representative** in response to final pre-clearing check findings as required.

The **Environment Manager** should:

- a) inform clearing contractors of any recommendations made by the pre-clearing report and pre-clearing check including for staged habitat removal, sequencing, timing or clearing methods.
- b) clearly communicate to clearing contractors that areas, subject to a pre-clearing survey, are marked in the field (e.g. exclusion zones).



Figure 1.6: Tree-guards can be installed on trees during the pre-clearing process to prevent climbing animals being present during clearing (Photo: Brenton Hays, TfNSW)

Unexpected threatened species finds procedure template

Purpose

This procedure template details the actions to be taken when a threatened species or threatened ecological community (TEC), or any species or ecological community that may be threatened, is unexpectedly encountered on site following project approval/determination and this impact has not been assessed as part of the environmental impact assessment undertaken for the project.

Induction/Training

Photos and a description of threatened biodiversity occurring or likely to occur within the project boundary should be included in the Construction Environmental Management Plan (CEMP) and/or the Flora and Fauna Management Sub-plan (FFMSP). All personnel are to be inducted on the potential threatened biodiversity occurring on site and the unexpected threatened species finds procedure.

Scope

This procedure template is applicable to all activities that have the potential to unexpectedly impact upon threatened biodiversity.

Procedure

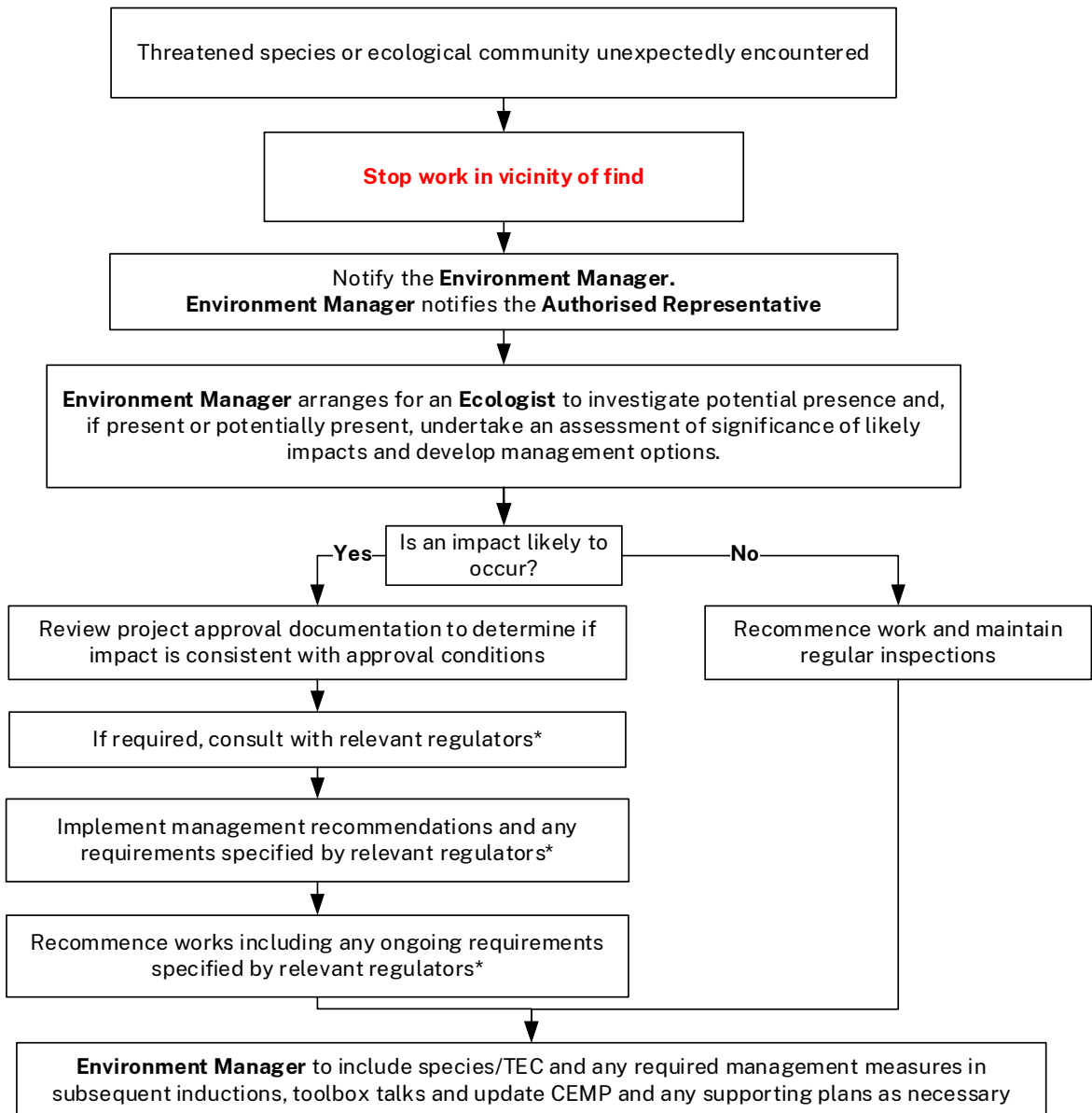

***Relevant regulators include:**

- NSW Department of Climate Change, Environment, Energy and Water (state listed terrestrial biodiversity)
- NSW Department of Primary Industries (state listed aquatic biodiversity)
- Commonwealth Department of Climate Change, Environment, Energy and Water (nationally listed biodiversity)

Figure 1.7: Unexpected threatened species finds procedure template

Supporting documents

Environmental assessment and associated supporting documents (e.g. ecological report, conditions of approval).

Environmental management plans and associated sub-plans and procedures for the works.

NSW Resource Recovery Order under Part 9, Clause 93 of the Protection of the Environment Operations (Waste) Regulation 2014. The mulch order 2016.

Related Transport for NSW documents and other resources

Sydney Trains [EMS-06-WI-0178 Fauna Impact Mitigation When Clearing Vegetation.pdf](#)

Transport for NSW [Microbat Management Guidelines: A guide for undertaking works in culverts, bridges and other structures](#) (Access via the TfNSW Environment and Sustainability Source SharePoint site or the [TfNSW Biodiversity webpage](#)).

Transport for NSW QA Specification for roads [G40 Clearing and Grubbing](#) (Access via the TfNSW intranet 'CPS documents directory' page).

Transport for NSW QA Specification [G36 Environment Protection](#) for road (Access via the TfNSW intranet 'CPS documents directory' page).

Transport for NSW Standard requirements (Works Contract) DMS-FT-425 (PDF, 745.67 KB) for rail (Access via <https://www.transport.nsw.gov.au/projects/project-delivery-requirements>)

Transport for NSW [Tree and Hollow Replacement Guideline](#) (Access via the TfNSW Environment and Sustainability Source SharePoint site).

External access to relevant Transport for NSW documentation can be requested by emailing environmentandsustainability@transport.nsw.gov.au.

Overview – Guide 1: Pre-clearing process

Objective

The objective of this Guide is to provide guidance for the pre-clearing process that should be conducted before any clearing takes place to minimise the impact on native flora and fauna.

Application of this Guide

This Guide is applicable where all or some of the following conditions are met:

- Threatened flora populations, threatened fauna and/or a threatened ecological community (TEC) has been identified to occur or potentially occur in the area during the environmental assessment process.
- Hollow-bearing trees, including standing dead trees with hollows are to be removed.
- Native or non-native vegetation that is likely to provide habitat for resident native fauna.
- Bushrock is to be removed.
- Potential roosting habitat for microbats (e.g. in bridges or culverts) is to be disturbed or removed.

Management requirements

- The **Environment Manager** should:
 - a. Review the environmental assessment to identify known locations of biodiversity features and any required management measures,
 - b. Review the CEMP and supporting FFMS. Key strategies include consultation with an **Ecologist** to:
 - Determine the location of suitable habitat for release of fauna that may be encountered during clearing.
 - Determine if staged habitat removal is warranted given impacts to habitat ([Guide 4: Clearing of vegetation and removal of bushrock](#)).
 - Develop an Unexpected Threatened Species Finds Procedure utilising provided template.
 - c. Incorporate all required actions in relevant clearing plans.
- Undertake a pre-clearing survey at least one week before clearing commences to:
 - a. Confirm the locations of biodiversity features.
 - b. Identify fauna that have the potential to be disturbed as a result of clearing activities.
 - c. **Ecologist** checks for the presence of threatened species that were identified in the environmental assessment as likely to occur. Undertake checks during optimal conditions for the target species where possible.
 - d. Record the details for all hollow-bearing trees, trees containing threatened fauna and flora, and any other habitat features.
 - e. Mark habitat features to be protected during construction and/or temporarily retained as part of a staged clearing process.

- f. Confirm the location of pre-determined habitat identified for the release of any fauna encountered on site.
- g. Submit and updated maps/plans, pre-determined habitat for the release of fauna, habitat features and recommended clearing procedures to the **Environment Manager** and **Authorised Representative**.
- Undertake a pre-clearing check no more than 24 hours before clearing commences to:
 - a. **Licensed handler** and/or **Ecologist** should capture and/or remove fauna that have the potential to be disturbed as a result of clearing activities.
 - b. Relocate fauna into pre-determined habitat identified for fauna release.
 - c. All fauna handling to be carried out by **licensed handler** and/or **Ecologists** and in accordance with Guide 9: Fauna handling.
 - d. Inform clearing contractors of any changes to the sequence of clearing if required including any requirements for staged habitat removal.
 - e. Carry out staged habitat removal as outlined in Guide 4: Clearing of vegetation and removal of bushrock where fauna habitat features have been identified and marked.

Guide 2: Exclusion zones

Background

An exclusion zone is a designated 'no-go' area that is clearly identified and appropriately fenced to prevent damage to native vegetation and fauna habitats, minimise the distribution of weeds and disease and reduce the likelihood of fauna entering construction. Exclusion zones may also be used to define approved clearing limits for a project and areas where temporary fauna exclusion measures are required.

Ecological features that have been identified for retention during the planning/development phase of a project may require protection during the construction/implementation phase. This could include:

- Vegetation outside of the assessed and approved clearing limits including individual trees.
- Individual native and amenity trees to be retained within clearing limits.
- Threatened flora.
- Threatened ecological communities.
- Hollow-bearing trees.
- Aquatic habitats.
- Areas of bushrock.
- Areas that are infected by pathogens or areas that need to be protected from pathogens.
- Conservation areas and habitat features identified as being of ecological significance including vegetation required to support proposed connectivity structures.



Figure 2.1: Example of mulch bund and construction flagging delineating the construction zone from the environmental protection area (Photo: Anthony Arena, TfNSW).



Figure 2.2: Exclusion fencing around a retained threatened Bailey's Cypress Pines (*Callitris baileyi*) on the Bruxner Highway (Photo: Ben Christiansen, TfNSW).

Such features can be inadvertently damaged or cleared during the construction process if not protected. Damage can result from movement of machinery, vehicles and personnel and may be direct (clearing outside approved limits) or indirect (spread of weeds into conservation zones, soil compaction in root zones).

Additionally, fauna may need to be excluded from construction areas. Projects that result in wildlife connectivity impacts (or where fauna vehicle strike is a possibility) may require temporary fauna exclusion measures during construction. This is a measure that is established around the clearing boundary typically immediately post clearing that aims to keep fauna out of construction zones (e.g. temporary fencing).

Objective

The objective of this Guide is to provide a process for determining and establishing exclusion zones to prevent damage to native vegetation (including individual trees) and fauna habitats, minimise the distribution of weeds and disease, and reduce the likelihood of fauna entering construction zones.

Application of this Guide

This Guide is applicable where areas within or adjacent to the work site require exclusion. Exclusion zones may be for significant vegetation, threatened species, weeds, pathogens habitat features, individual trees and/or management of fauna access.

Specialist input requirements

Use a qualified surveyor to mark out exclusion zones and clearing limits where clearing limits have been specified in an approval and in other situations wherever practical.

For individual trees located within construction boundaries and identified for retention, seek the advice of an **AQF Level 5 Arborist** when recommendations about identifying Tree Protection Zones (TPZ) in this Guide cannot be applied or where incursions to a TPZ are unavoidable.

Use qualified **Ecologists** to determine the appropriate type and location of any temporary fauna exclusion measures required.

Management requirements

Determining exclusion zones

The **Environment Manager** should undertake the following general steps before construction begins:

1. Review background information including:
 - Environmental assessments and accompanying flora and fauna reports.
 - Conditions of approval.
 - Project or Construction Environmental Management Plans (CEMP).
 - Project or contract specifications.

- Updated maps/plans showing pre-determined habitat for the release of fauna and habitat features that were provided to the Environment Manager by an Ecologist as part of the pre-clearing process.

2. Select exclusion fence type / delineation method considering:

- The risk of the excluded area being intruded upon. This should consider the sensitivity of what is being excluded, accessibility to the excluded area, the limitations of fencing options and the type and number of plant and equipment.
- The need to exclude fauna (particularly threatened species) from construction zones.
- The area to be fenced/delineated.
- Cost.
- The risk of fauna being trapped, injured or isolated (e.g. barbed-wire fencing should not be installed in a designated wildlife crossing zone).



Figure 2.3: Example of temporary construction fauna exclusion fencing on the Nelson Bay Road Upgrade (Photo: Elle Hutchinson, TfNSW).

3. Mark exclusion zones on a suitable plan. Suitable plans should:

- Be based on up to date plans for the project such as design drawings issued 'for construction'. E.g Vehicle turning circles and parking areas should be clearly marked.
- Include an aerial photograph image underlay.
- Show construction chainages or similar distance markers used in construction.
- Be clearly labelled, including the type of the exclusion fence to be used and any other information relevant to the installation and maintenance of the exclusion zone.
- State what is being excluded. In some circumstances, the reason for exclusion may not be able to be identified on plans or signs due to security and/or cultural sensitivity e.g. rare orchids.
- Be displayed in prominent places in site sheds, included in environmental management plans and provided in the site induction.
- Outline any procedures that must be followed for access into exclusion zones.

4. Establish fencing/delineation limits prior to commencement of the project including:

- Mark out exclusion zones with temporary markings such as pegs or paint. Locations of pegs must be verified by qualified surveyor in accordance with QA Specification G71 Construction Surveys.



- Temporary markers at to be placed no more than 25m apart along clearing boundary, and no more than 2m apart adjacent to high risk or critical habitats.
- Survey pegs to be numbered to identify order or placement for temporary fencing around high risk or critical habitats.
- Temporary fencing to be installed for duration of construction between marker / peg locations.





Figure 2.4: Example of temporary construction fauna exclusion fencing targeting koala on the Bonville Pacific Highway Upgrade Project (Photo: Scott Lawrence, TfNSW).

Table 2.1 presents a list of potential fencing options for the **Environment Manager** to choose from. Note, this list is not exhaustive and other options may be suitable considering the risk of intrusion and the sensitivity of the excluded area. Additionally, where temporary fauna exclusion fencing is required, the type of fencing will depend on the target fauna species, e.g. frog or koala exclusion fencing.

Table 2.1: Options for fencing of exclusion zones

Fencing option	Examples	Description	Advantages	Disadvantages
Type 1	 <p>Figure 2.5: Example of chain wire fencing (Photo: TfNSW)</p>	<p>Chain wire fencing for high risk and highly sensitive sites.</p> <p>Appropriate for excluding most larger fauna species.</p>	<p>Allows for a greater degree of protection due to the sturdiness of the fencing.</p> <p>Greatly reduces the risk of intrusion into environmentally sensitive areas.</p> <p>Sturdy high fence will exclude most large-ground-dwelling fauna species. Modifications can target specific species (e.g. to prevent climbing or digging).</p> <p>Can be installed without concrete footings.</p>	<p>Vegetation may need to be cleared.</p> <p>Installation may not be possible before works begin, which increases the risk of entering exclusion zones (thus a different fence type may be needed in the interim).</p> <p>Fauna may become trapped inside due to its low permeability. If this occurs, fauna will need to be removed by a licensed handler and/or Ecologist in accordance with Guide 9: Fauna handling.</p> <p>Relatively high cost.</p>
Type 2	 <p>Figure 2.6: Example of temporary fencing (Photo: Julie Ravallion, TfNSW)</p>	<p>Metal fence panels that join with simple weighted footings and clamps.</p>	<p>Relatively easy and quick to install on flat to mildly sloped surfaces.</p> <p>Does not require any ground penetration.</p> <p>Allows for a greater degree of protection than Type 3 due to the relative sturdiness of the fencing.</p> <p>Can have gates easily integrated for access.</p>	<p>Needs high-visibility material in some circumstances.</p> <p>Not suitable to deter smaller fauna species without additional treatment along bottom rail.</p> <p>Not suitable for steep slopes.</p> <p>Ongoing cost associated with hire.</p>

Fencing option	Examples	Description	Advantages	Disadvantages
Type 3	 <p data-bbox="423 667 869 727">Figure 2.7: Example of para-web fencing (Photo: Rebecca Vaughan, TfNSW)</p>	<p data-bbox="972 304 1227 746">Para-web material and star pickets are most commonly used for temporary fencing of specific and small areas (e.g. individual trees, small pockets of vegetation), or where there is high/moderate risk of intrusion.</p>	<p data-bbox="1256 304 1615 515">Highly visible. Relatively easy and quick to install (where substrates are not rocky). Moderate cost.</p>	<p data-bbox="1664 304 2134 703">Does not physically prevent intrusion. Not as strong as Type 1 and Type 2 fencing and therefore more easily damaged. Not appropriate for most fauna exclusion. Para-web material may exclude some small species (e.g. non-climbing frogs), however additional specific design features are required (e.g. material is dug into the ground).</p>
Type 4	 <p data-bbox="423 1189 869 1249">Figure 2.8: Example of reflective bunting (Photo: Brenton Hays, TfNSW)</p>	<p data-bbox="972 799 1227 1050">Capped star pickets and bunting with reflective flags is typically used for larger areas with moderate/low risk of intrusion.</p>	<p data-bbox="1256 799 1615 1082">Can be installed quickly and easily (where substrates are not rocky). Low cost. Different colours should be used for different exclusion zones.</p>	<p data-bbox="1664 799 2134 1010">Moderate visibility and may be overlooked. Not as strong as other fencing types and therefore more easily damaged. Not appropriate for fauna exclusion.</p>

Establishing the exclusion zone

The following guidance applies when establishing exclusion zones:

- Allow enough lead time to establish exclusion zones before clearing. Marking of exclusion zones could be carried out during the pre-clearing process or at the same time as the marking out of the construction footprint.
- Mark out exclusion zones with temporary markings such as pegs or paint and, where possible, use a qualified surveyor.
- During clearing, trees are felled so as to fall away from the exclusion zone. Do not stockpile felled vegetation or any other matter into exclusion zones without consultation with from the **Environment Manager**.
- If fauna exclusion measures are required and cannot be installed before clearing (e.g. fencing), they are to be established immediately after clearing.
- Erect signs to inform personnel of the purpose of the fencing. Signs should be clearly visible from a distance of at least 20 metres and be general in nature, such as 'Exclusion Zone' or 'Environmental Protection Zone'.
- Store materials or equipment outside the exclusion zone
- Locate construction parking, compounds, stockpiles and chemical storage away from vegetated areas including exclusion zones.



Figure 2.9: An example of tree protection using flagging on Barton Highway project (Photo: Amy Evans, TfNSW).

Establishing tree protection zones (TPZ)

Individual native and amenity trees within construction boundaries should be retained wherever possible or as required by approval conditions from the environmental assessment. The tree protection zone (TPZ) represents the area around a tree identified for retention that should not be disturbed. Disturbing the TPZ may damage the root system and the health of the tree. To be consistent with Australian Standard (AS 4970), TPZs are to be established prior to construction activities near trees which are to be retained and maintained for the duration of construction activities.

The TPZ can be calculated as twelve times the DBH (Diameter at Breast Height) of the tree. For example, a 0.5 metre diameter tree at breast height would have a TPZ of 6 metre radius, which would give a 12 metre diameter TPZ. DBH is generally measured at 1.4 metre above ground level, or as shown in Appendix A of the AS4970 for trees on slopes, multi-trunked and leaning trees, and other variations.

An alternative approach¹ involves using the tree dripline plus an additional 1m buffer to define the TPZ (Figure 2.10)². Using this approach would be consistent with the Australian Standard for tree with a DBH of less than 50 centimetres. Where either approach is not possible, the advice of an **AQF5 arborist**, and/or person with **Diploma of Horticulture (Arboriculture)** and/or equivalent experience is required.

To be consistent with Australian Standard (AS 4970), fencing needs to prevent access by machinery to the tree protection zone and have a minimum height of 1.8 metres unless local conditions preclude this. Shade cloth or similar should be attached to reduce the transport of dust and other matter and liquids.

To be consistent with Australian Standard (AS 4970), fence posts need be located clear of obvious roots. Install signs clearly identifying the tree protection zone (see example sign in Figure 2.11).

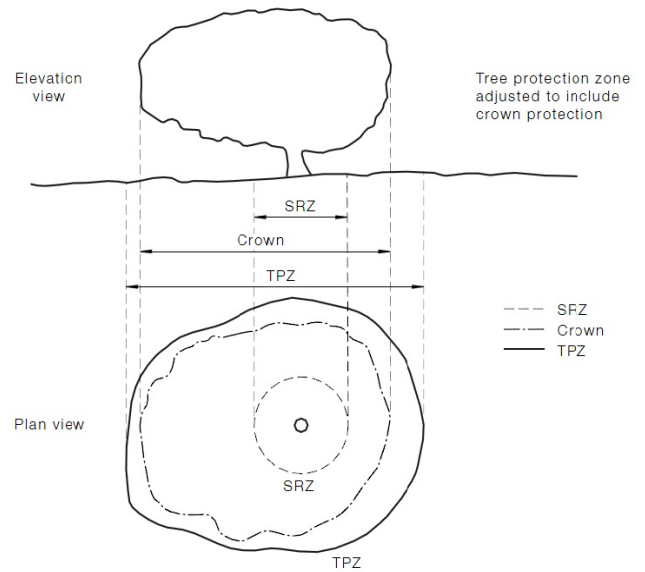

Figure 2.10: Alternative approach¹ to calculating a tree protection zone (TPZ) including canopy protection. Australian Standard AS4970 (Reproduced with permission²)



Figure 2.11: Example Tree protection zone sign Australian Standard AS4970 (Reproduced with permission²)

¹ Not appropriate for mature trees with a narrow, upright growing habitat such as Norfolk pines. Seek Arborist advice for these trees.

² Reproduced by Transport for NSW with the permission of Standards Australia Limited under licence CLF1222TFNSW. Copyright in AS 4970-2009 vests in Standards Australia and Standards New Zealand. Users must not copy or reuse this work without the permission of Standards Australia or the copyright owner.

Managing unavoidable encroachments

Branch and trunk protection and measures to reduce soil compaction are required where construction works are in very close proximity to trees (see in Figure 2.12).

Encroachment including excavation, compacted fill and machine trenching within a TPZ may be undertaken in a manner that will minimise impacts to tree health. However, this requires assessment, calculation and management by a **AQF5 arborist** and is best avoided if possible. Root mapping may be required to determine the extent of encroachment.

Trenching and underground boring

Trenching may be required close to trees as part of construction activities. Severing the root structure of a tree can lead to destabilisation, structural failure or death of the tree.

To be consistent with Australian Standard (AS 4970), trenching is to be done outside of the TPZ. Trenching within the TPZ may only be done in consultation with an **AQF5 arborist**.

Trenching may require root pruning with the **AQF5 arborist** approval and supervision. Roots should first be severed cleanly to the depth of the future excavation. The trench should then be hand dug and roots pruned.

Severed roots need to be kept protected and managed in accordance with the **AQF5 arborist's** recommendations. If trenching is required within the TPZ, an alternative method such as underground boring can be used.

Maintenance and monitoring

The **Environment Manager** should oversee the following:

- Monitor the health of retained vegetation and seek advice from an **AQF5 arborist** if vegetation shows signs of stress (discolouration, die back, wilting).
- At least weekly inspections of exclusion zones and tree protection zones. Repairs to fencing are made where required.

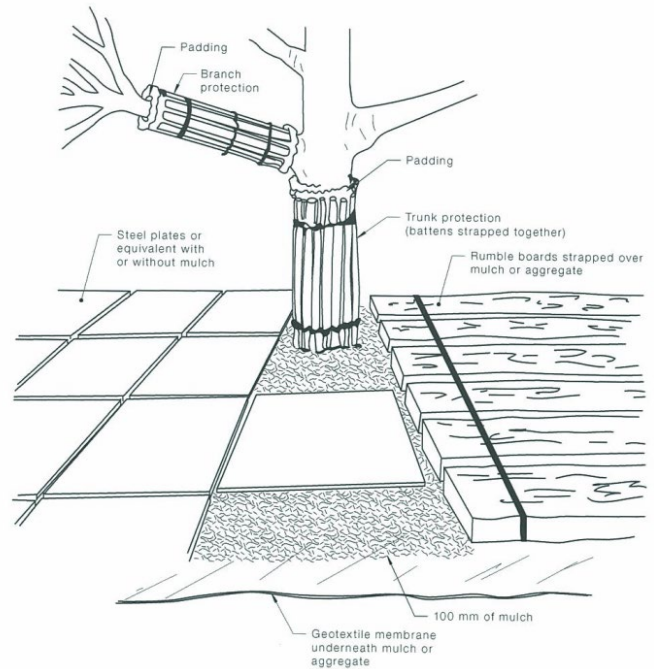

Figure 2.12: Examples of branch, trunk and root protection from Australian Standard AS4970 (Reproduced with permission²)

- Additional checks should be undertaken following storms where there is a higher risk of material falling on fencing. Inspections of exclusion zones should form part of regular site environmental checks.
- Regular assessments of the adequacy and location of exclusion zones by including this as an auditable item in the project audit schedule.
- Maintain exclusion fencing until the risk to disturbance within the excluded zone has been eliminated through other means.
- Removal of fencing should be undertaken in consultation with **Environment Manager** and the **Authorised Representative**.
- Communication of the importance of tree protection zones, and any changes to the zones, to all site staff (e.g. in toolbox talks). Carry out formal inductions (including visitor inductions) regarding the location and purpose of exclusion zones on site.
- Use only defined access tracks and entry/exit points for all vehicle movements.
- Do not store materials, perform wash-down or equipment maintenance or park equipment/vehicles within TPZs. Seek advice from **AQF5 Arborist** to identify a suitable TPZ where necessary and when planning and undertaking unavoidable encroachments within the TPZ.
- Reporting of any breaches of the exclusion zone and TPZs through the EMF-EM-PR-0001 Environmental Incident Procedure.



Figure 2.13: An example of poor practice. Construction materials should not be piled against trees and should be located outside the tree protection zone (Photo: Mel Cotterill, TfNSW).

Supporting documents

Environmental assessment and associated supporting documents (e.g. ecological report, conditions of approval).

Environmental management plans and associated sub-plans and procedures for the works.

Australian Standard 4970 (2009) Protection of Trees on Development Sites.

Design documentation for projects detailed mapping of clearing limits, boundary locations and clearing footprint.

Related Transport for NSW documents and resources

EMF-EM-PR-001 [Environmental Incident Procedure](#). Available on the TfNSW Environment and Sustainability Source SharePoint site

Sydney Trains [EMS-06-GD-0067 Vegetation Management in the Corridor.pdf](#)

Sydney Trains [EMS-06-WI-0150 Environmentally Sensitive Site Signage Work Instruction.pdf](#)

Sydney Trains [EMS-06-WI-0178 Fauna Impact Mitigation When Clearing Vegetation.pdf](#)

Transport for NSW Standard requirements (Works Contract) DMS-FT-425 (PDF, 745.67 KB) for rail (Access via <https://www.transport.nsw.gov.au/projects/project-delivery-requirements>)

Transport for NSW QA Specification for roads [G40 Clearing and Grubbing](#) (Access via the TfNSW intranet 'CPS documents directory' page).

Transport for NSW QA Specification [G36 Environment Protection](#) for road (Access via the TfNSW intranet 'CPS documents directory' page).

Transport for NSW QA Specification [G71 Construction Surveys](#) (Access via the TfNSW intranet 'CPS documents directory' page).

External access to relevant Transport for NSW documentation can be requested by emailing environmentandsustainability@transport.nsw.gov.au.

Overview – Guide 2: Exclusion zones

Objective

The objective of this Guide is to provide a process for determining and establishing exclusion zones to prevent damage to native vegetation (including individual trees) and fauna habitats, minimise the distribution of weeds and disease, and reduce the likelihood of fauna entering construction zones.

Application of this Guide

This Guide is applicable where areas within or adjacent to the work site require exclusion and for the protection of trees within development sites.

Exclusion zones may be for significant vegetation, threatened species, weeds, pathogens or habitat features and/or fauna access. Tree protection zones (TPZ) may be required for trees identified for protection within construction boundaries.

Management requirements

Review background documents such as environmental assessment reports, applicable management plans and updated maps/plans that were developed as part of the pre-clearing process.

- Select exclusion fence type considering:
 - a. The risk of the excluded area being intruded upon.
 - b. The need to exclude fauna.
 - c. The area to be fenced.
 - d. Cost.
 - e. The risk of fauna being trapped, injured or isolated.
- Mark exclusion zones on a suitable plan. Plans should:
 - a. Be based on up to date plans for the project.
 - b. Include an aerial underlay.
 - c. Include construction chainages.
 - d. Be clearly labelled and state what is being excluded.
 - e. Be displayed in prominent places in the site shed.
 - f. Outline procedures that must be followed to access the exclusion zone.
- Allow enough lead time to establish exclusion zones before clearing.
- Mark out exclusion zones with temporary markings such as pegs or paint and, where possible, use a qualified surveyor.
- During clearing, felled trees are kept out of the exclusion zone. Do not stockpile felled vegetation into exclusion zones without consultation with the **Environment Manager**.
- Erect signs indicating the purpose of the fencing.
- Store materials or equipment outside exclusion zones.

- Avoid stockpiling materials and equipment and parking vehicles and machinery within the tree protection zone of any tree.
- Exclusion zones are to be regularly inspected and repairs to fencing are made where required.
- Carry out regular assessments of the adequacy and location of exclusion zones by including this as an auditable item in the project audit schedule.
- Maintain exclusion fencing until the risk to disturbance within the excluded zone has been eliminated through other means.
- Communicate the importance of exclusion zones, and any changes to the zones, to all site staff and visitors (e.g. in toolbox talks and inductions).
- Any breaches of the exclusion zone are reported through Environmental Incident Procedure EMF-EM-PR-001.
- Monitor the health of retained vegetation and seek advice from an **AQF5 arborist** if vegetation shows signs of stress (discolouration, die back).
- For trees to be retained within construction areas, identify and protect tree protection zones and follow *Australian Standard 4970 Protection of trees within development sites*. Obtain **AQF5 arborist** advice for unavoidable encroachments to tree protection zones.

Guide 3: Re-establishment of native vegetation

Background

Re-establishment of native vegetation can be achieved through revegetation. Revegetation serves a number of purposes including visual screening, air quality improvements, erosion and sediment control, carbon sequestration, mitigation of the heat island effect associated with urban environments as well as providing habitat resources for native fauna.

All revegetation works should be based on sound ecological principles and be undertaken in accordance with [TfNSW Landscape Design Guideline](#). Consultation and collaboration between **Ecologists** and **Landscape Designers** is recommended. The [Transport Biodiversity Policy](#) also requires native and amenity trees and tree hollows to be replaced for certain TfNSW projects, which is addressed in the separate [Tree and Hollow Replacement Guidelines](#).

Objective

The objective of this Guide is to promote good biodiversity outcomes, where native vegetation re-establishment is required, by managing site conditions, material sourcing and procurement, and seed and plant stock installation and establishment.

Positive biodiversity outcomes (e.g. Figure 3.1) may be achieved through well planned and designed native revegetation and landscaping that:

- Clearly integrates ecological objectives into landscape plans including revegetating around connectivity structures to encourage fauna use.
- Preferences locally sourced seed and plant material.
- Focuses on vegetation that provides habitat and fauna connectivity.
- Supports third party requests to salvage plants, plant part or seeds prior to clearing.
- Is maintained and monitored till established.

Application of this Guide

This Guide is applicable to all TfNSW projects where native vegetation is required to be planted or re-established and should be read in conjunction with the [Transport Biodiversity Policy](#) and [Tree and Hollow Replacement Guidelines](#).



Figure 3.1: Koala (*Phascolarctos cinereus*) browsing on three year old koala feed trees planted as part of the Woolgoolga to Ballina Upgrade of the Pacific Highway (Photo: Sandpiper Ecological Surveys).

Specialist input requirements

Licensed seed collectors are required to carry out any native seed collection required. It is recommended that any seed collection contractors employed by TfNSW adopt [Florabank Guidelines](#) and *Florabank Model Code of Practice* to ensure best practice seed collection.

Ecologists and **Landscape Designers** should work together on the preparation of revegetation and landscape management plans and specifications.

Management requirements

When re-establishing native vegetation, the **Environment Manager** should ensure the following steps are undertaken (where relevant):

1. Identify areas for the re-establishment of native vegetation.

Clearly identify the locations of areas to be revegetated on landscape plans.

2. Carry out native seed collection.

Native seeds are an important resource for revegetation efforts and seed salvage should be considered where clearing over 1ha will occur.

Allocate sufficient time for the collection of seed. This could involve collecting seed up to 12 months in advance of the revegetation works.

Key actions include:

- Seed should first be collected from all areas that are to be cleared as part of the infrastructure project. By selecting a seed source that is from plants growing in similar environmental conditions nearby, the plants should be naturally adapted to local conditions and more likely to survive and prosper.
- Carry out all seed collection in accordance with [Florabank Guidelines](#) and *Florabank Model Code of Practice*. Experienced and **licensed seed collectors** should carry out the seed collection.
- Where the seed resources from areas to be cleared are not sufficient or available, additional seed may need to be collected from the region for the revegetation works. Selection of suitable seed collection sites is critical for the genetic diversity of plant seed and for matching the environmental conditions at planting.

3. Procure native plants.

Where possible, plants should be grown from local provenance seeds. This can only be achieved if sufficient time has been made available after seed collection to allow for adequate growth for successful planting or there is an available supply of indigenous plants from a local nursery. This will enable plants to be well suited to the area resulting in less maintenance, better plant health, better establishment and better compatibility with local flora and fauna species.

Native plants may need to be specially grown and sourced for use in the revegetation works. These plants need to be appropriately selected in consultation with **Landscape Architects** and **Ecologists**. Consideration should be given to a range of characteristics such as species, height and drought tolerance.

Plants should be robust and of a sufficient size to handle planting operations and exposure to road/rail microclimates. The pot size and root-ball development can be a key factor in the plant survival rate (Figure 3.2).

Where native plants grown from local provenance seed are not available, then native species grown from seed collected from the region are acceptable. Refer to Landscape Guideline Appendix B which provides prioritisation list for native provenance. All SWTCs (Scope of Work Technical Criteria) reference the guideline directly. Utilise QA Specification R179 Clause 2.3 Plant Material in project documentation.

However there needs to be a clear demonstration that local native seed sources for planting are not available. Consultation with **specialists** may be required if native plants of local provenance are not readily available.

Use only plants that have been certified disease free for revegetation works. Nurseries usually obtain this certification from relevant bodies such as the Botanic Gardens Trust. See Guide 7: Pathogen management.

4. Prepare the ground

The principal factor governing the quality of revegetation is the ground conditions. Creating the right ground conditions will significantly assist good biodiversity outcomes.

In ideal circumstances, re-creating natural ground conditions by spreading soils that are collected from site (and appropriately stored in accordance with RMS Stockpile Site Management Guideline (2015) leads to natural regeneration of local species and the best revegetation outcome. Some projects or areas of projects have been able to achieve this outcome.

Natural regeneration may not be possible due to drainage changes, differing light levels, wind exposure, soil damage, construction techniques and weed infestation.



Figure 3.2: Different container sizes for planting. Note the deep-rooted pot for the Forestry tube stock which is preferable for trees. The shorter Hiko and tube stock pots may also be suitable for trees but are well suited for shrubs (Photo: John Chang, TfNSW).



Figure 3.3: Topsoil being stockpiled at Moree for re-use later in revegetation and landscaping works (Photo: Lester Piggott, TfNSW).

However, there are a few principles that may help achieve the right ground conditions:

- Collect local native topsoils and leaf litter and store for use in the revegetation works. Carry out tests on the stockpiled topsoil in accordance with [TfNSW NSW QA Specification R178 Vegetation](#). Where possible avoid the need to import soils and prevent weed infestation. See [Guide 6: Weed management](#), the [RMS Stockpile Site Management Guideline](#), [Guidelines for Batter Surface Stabilisation using vegetation](#) and the 'Blue Book' ([Managing urban stormwater Vol 1](#)) for more information on weed management and stockpiling soils (Figure 3.3).
- Consider the physical and chemical properties of the soils and their organic profile. Soil in areas to be revegetated should match surrounding soil conditions as closely as possible unless adjacent areas are weedy or contaminated. Refer to [Guidelines for Batter Surface Stabilisation using vegetation](#) for consideration of ameliorants and other additives to soils, including mulch.
- Consider areas to be revegetated have an appropriate level of natural drainage that is not impeded by surrounding underground or surface structures or prone to water logging. Isolated pockets of land surrounded by hard surfaces should be avoided.
- Avoid compaction of soils in areas identified for revegetation. Where compaction has occurred, the soil should be loosened.

5. Seeding

Once collected, native seed needs to be sown in a manner to suit the species. Consider the soil type and depth, the moisture availability, aspect and the season in which the species should be planted. Seed should receive adequate moisture to allow it to germinate before it is blown or washed off the landscape. There are several seeding techniques that deal with moisture requirements in different ways, including techniques for assisting seed germination. The different techniques are summarised in Table 3.1. For further details see [Guidelines for Batter Surface Stabilisation using vegetation \(2015\)](#).

Table 3.1: Techniques³ for planting native seeds and assisting germination

Term	Definition
Hand sowing	Distribution of seed by manually spreading onto prepared ground. Hand sowing is best suited to areas that are small and difficult to access or in ecologically sensitive areas.
Direct seeding (Figure 3.7)	Also called 'seed drilling', this is the application of seed mechanically into the ground by rotary or agricultural equipment. Direct seeding is best suited to areas that are even, linear and not steep (e.g. road medians).
Hydroseeding (Figure 3.4)	The spraying of seed and soil ameliorants in water onto the landscape providing a brief period of moist conditions and ensuring the seed is well spread out and carried to the ground. Hydroseeding is best suited to moist climates or seasons, where suitable topsoil is present. Avoid using in hot, dry conditions. Typically followed by hydromulching or straw mulching to

³ The technical and application information for the different types of stabilisation options in this guideline should be checked with project and work delivery requirements.

	<p>assist germination and provide erosion protection until vegetation establishes.</p>
<p>Hydromulching (Figure 3.8)</p>	<p>Typically applied after hydroseeding, Hydromulch consists of various types of organic fibrous materials (e.g. paper / wood pulp, wood fibre, straw fibre or milled cane fibre) mixed with water and sprayed onto the soil surface in slurry form that sets to provide erosion protection and moisture retention. Seed is sometimes added, however ideally seed should be applied separately prior to mulching to ensure good contact with the soil. Food-based dyes are commonly added to provide a blue or green colouring to identify coverage.</p>
<p>Straw mulching (Figure 3.6)</p>	<p>A blanket of straw blown over hydroseeded areas. It requires a tackifier (adhesive), to bind the straw together. This may also be done using sugar cane toppings (as long as they have been inspected for 'hitchhikers' like cane toads). Straw mulching provides raindrop splash erosion protection and moisture retention and thermal insulation.</p>



Figure 3.4: Hydroseed application on a prepared batter (Photo: TfNSW).



Figure 3.5: Diverse vegetation establishment resulting from hydroseeding overlaid with hydromulch on the Kempsey Bypass. (Photo: TfNSW).



Figure 3.6: Straw mulching over a hydroseeded embankment. A tackifier (adhesive) is sprayed over the straw to bind it in place. The materials used must be appropriate to the local context, and consider fire risk, high wind and erosion profiles (Photo: Leigh Trevitt, TfNSW).



Figure 3.7: Direct seeding a batter (Photo: Martin Sullivan, TfNSW).



Figure 3.8: Hydromulch being sprayed on a batter on the Hunter Expressway (Photo: TfNSW).

6. Planting

When planting, the following general steps should be undertaken:

- Planting operations should be in accordance with TfNSW NSW QA Specification R178 Vegetation and R179 Landscape Planting for roads.
- Consider seasonal risks of frost, drought, flooding and sun exposure to avoid damaging plants and to encourage growth.
- Plant spacing follows the landscaping plan for the project, reflects local conditions and is dense enough for plants to achieve a timely coverage of the ground, which helps minimise erosion and/or weed invasion (Figure 3.9 and Figure 3.10).



Figure 3.9: Planting carried out in an exposed location. Weed competition is evident and the plants may fail (Photo: Paul Murray, TfNSW).



Figure 3.10: Planting with a diverse range of species that are representative of the nearby vegetation communities around the Pacific Highway at Karuah (Photo: Paul Murray, TfNSW).

- Diversity and spacing of plants is representative of nearby vegetation communities in the area. Consider species composition and structure of the locality when developing landscaping plans.
- Consider appropriate shade and drainage conditions when planting. This may include clustering species near mature plants or in the vicinity of existing stands rather than in exposed open conditions.
- Provide a 75 mm deep layer of mulching around plants for dry or potentially weedy sites to help retain moisture and suppress weeds. Mulch also aids soil stabilisation and protection. Inspect sugar cane mulch for the presence of Cane Toads (*Rhinella marina*) or other 'hitchhikers' from outside areas (e.g. Red Imported Fire Ants). It is recommended that any Cane Toads seen are:
 - a. Reported in accordance with [DPI requirements](#); and
 - b. Caught immediately using protective clothing/gloves/eyewear. See [Guide 9: Fauna handling](#) for more information on Cane Toad identification.

7. Maintenance and monitoring:

Maintenance and monitoring of revegetation areas is required to ensure revegetation efforts are not wasted due to weed invasion, lack of watering and damage by grazing animals both native and introduced.

The **Environment Manager** should ensure that ongoing maintenance and monitoring of revegetated areas is conducted in accordance with the landscape management and revegetation plans and maintenance specifications.



Figure 3.11: Ten years of rainforest revegetation, Banora Point Upgrade of the Pacific Highway. Photo on left taken post construction in 2012. Photo on right taken in 2022 showing progress over 10 year period (Photo: Alex Nicol, TfNSW).

A special note on Red Imported Fire Ants (*Solenopsis invicta*)

Red imported fire ants (fire ants) are invasive introduced ants that cause serious social, economic, and environmental harm. They are aggressive and have a severe, burning sting. Fire ants are known to occur in New South Wales and currently infest a large area of South-East Queensland. Fire ants are one of the highest biosecurity risks to NSW.

Fire ants are a prohibited matter under the *NSW Biosecurity Act 2015*. Their possible movement is regulated by the [NSW Department of Primary Industries \(DPI\)](#).

TfNSW are taking measures to reduce the likelihood of fire ants being inadvertently imported into NSW. Construction activities can contribute by:

- Ensuring field-based staff undertake free fire ant awareness training.
- Adopting good vehicle hygiene practices at all times.
- Including fire ant information in site inductions and toolbox talks and become familiar with fire ant first aid treatment.
- Being on the look-out for fire ant nests and contact NSW DPI immediately if a suspected nest is found.
- Ensuring any items considered 'fire ant carriers' obtained from 'fire ant infested area' are accompanied by an Interstate Biosecurity Certificate.

Fire ant carriers' include

- Organic mulch
- Soil and anything with soil on it
- Baled material
- Potted plants
- Turf
- Agriculture or earth moving machinery
- mining and quarrying materials

DPI define 'fire ant infested areas' as being land within a Queensland fire ant biosecurity zone AND land within a 5km buffer around known fire ant nests. See [DPI website for current NSW fire ant distribution](#).

If you suspect a nest of fire ants, take photos if safe and immediately:

- contact NSW DPI 1800 680 244 or [Report a Biosecurity Concern \(nsw.gov.au\)](#)
- if you identify fire ants whilst at work, also immediately contact your local environment and sustainability partner AND the Transport Services Functional Area Duty Officer (TSFADO) on 1300 770 247

Supporting documents

Department of Environment and Climate Change (DECC)(2008) 'Blue Book' Managing urban stormwater: Soils and construction, Volume 2D: Main Road Construction

Department of Primary Industries advice for the management of Cane Toad inclusions

Florabank (2022) Florabank Guidelines 1-15

Landcom (2004) 'Blue Book' Managing urban stormwater Vol 1

Related Transport for NSW documents and resources

Environment and Sustainability Red Imported Fire Ants (*Solenopsis invicta*) Alert January 2024 (as amended and updated)

Environment and Sustainability Non-complying imported mulch Alert February 2024 (as amended and updated)

Roads and Maritime Service (2015) Guideline for Batter Surface Stabilisation using vegetation

Sydney Trains EMS-06-GD-0068 Sowing Guide for Disturbed Site Stabilisation.pdf

Sydney Trains EMS-06-TP-0064 Bush Regeneration Technical Specification Template.DOCX

Sydney Trains EMS-06-TP-0066 Revegetation Technical Specification Template.DOCX

Transport for NSW Standard requirements (Works Contract) DMS-FT-425 (PDF, 745.67 KB) for rail (Access via <https://www.transport.nsw.gov.au/projects/project-delivery-requirements>)

Transport Biodiversity Policy (Access via the TfNSW intranet corporate policy library page)

Transport for NSW Landscape design guideline

Transport for NSW QA Specification R178 Vegetation and R179 Landscape Planting (Access via the TfNSW intranet 'CPS documents directory' page).

Transport for NSW QA Specifications G38 Soil and Water Management for road (Access via the TfNSW intranet 'CPS documents directory' page).

Transport for NSW Tree and Hollow Replacement Guideline (Access via the TfNSW Environment and Sustainability Source SharePoint site)

External access to relevant Transport for NSW documentation can be requested by emailing environmentandsustainability@transport.nsw.gov.au.

Overview – Guide 3: Re-establishment of native vegetation

Objective

The objective of this Guide is to promote good biodiversity outcomes, where native vegetation re-establishment is required, by managing site conditions, material sourcing and procurement, and seed and plant stock installation and establishment.

Application of this Guide

This Guide is applicable to all Transport projects where native vegetation is required to be planted or re-established.

If the revegetation works form part of tree and hollow replacement required under the TfNSW Biodiversity Policy then additional arrangements regarding long-term protection of the revegetated area would be required.

Management requirements

- Retain native vegetation by minimising the road construction footprint where possible rather than clearing and revegetating the area.
- **Ecologists** and **landscape architects** should work together on the preparation of revegetation plans and specifications that clearly identify the locations of areas to be revegetated.
- Allocate sufficient time for the collection of seed to be used in revegetation.
- Carry out all seed collection in accordance with and the [Florabank Guidelines](#) and *Florabank Model Code of Practice*.
- Use experienced and **licensed seed collectors** to carry out seed collection.
- Where possible, procured plants should be grown from local provenance seed.
- Consideration should be given to a range of characteristics such as species, height and drought tolerance when procuring native plants.
- Planting operations should be in accordance with [Transport for NSW Landscape Planting QA Specification R179](#).
- Use only plants that have been certified disease free for revegetation works. [Guide 7: Pathogen management](#).
- Collect local native topsoils and leaf litter and store for use in revegetation works.
- Soils in areas to be revegetated should match surrounding soil conditions as closely as possible unless adjacent areas are weedy or contaminated.
- Areas to be revegetated have an appropriate level of natural drainage.
- Avoid compaction of soils in areas identified for revegetation. Where compaction has occurred, the soil should be loosened.
- There are several seeding techniques that deal with moisture requirements in different ways. For further details refer to [Roads and Maritime Service \(2015\) Guideline for Batter Surface Stabilisation](#).

- When planting consider seasonal risks of frost, drought, flooding and sun exposure to avoid damaging plants and to encourage growth.
- Plant spacing and diversity follows the landscaping plan for the project, reflects local conditions and is dense enough to for plants to achieve a timely coverage of the ground.
- Consider appropriate shade and drainage conditions when planting. Provide mulching around plants for dry or potentially weedy sites to help retain moisture and suppress weeds.
- Inspection, monitoring and maintenance of revegetated areas should be conducted in accordance with the landscape management plan. Outline the roles and responsibilities in landscape management and revegetation plans including the schedule for monitoring and maintenance activities.

Guide 4: Clearing of vegetation and removal of bushrock

Background

Clearing of vegetation and/or removal of bushrock has the potential to displace, injure or kill native flora and fauna, including threatened species. Nocturnal fauna that shelter in tree hollows and bushrock during the day are at greatest risk of displacement, injury and death during these activities.

'The clearing of native vegetation', 'loss of hollow-bearing trees', 'removal of dead wood and dead trees', and 'bushrock removal' are Key Threatening Processes listed under the *Biodiversity Conservation Act 2016 (NSW) (BC Act)*.

Bushrock is loose rock found on rock or soil surfaces. Many fauna species use bushrock for shelter and to hide from predators, find food, avoid extreme weather and escape bushfires. Bushrock removal results in disturbance and removal of habitat for native fauna as well as some native flora that grow in rocky areas.

This Guide supports the Transport for NSW [QA Specification G40 Clearing and Grubbing](#) and provides additional guidance on undertaking clearing and grubbing works in an ecologically-sensitive manner.

Objective

The objective of this Guide is to minimise the impacts on biodiversity from loss of habitat because of the clearing process and to encourage removal of bushrock is done in a way that minimises loss and damage of native fauna and flora habitat.

This Guide is intended to provide best practice recommendations for the following works:

- Clearing of native vegetation (including grasslands).
- Clearing of exotic vegetation.
- Removal of waterbodies (e.g. dewatering farm dams) See also [Guide 10: Aquatic habitats and riparian zones](#).
- Pruning (from early works to maintenance).
- Removal of identified habitat (e.g. hollow-bearing trees, bushrock).
- Grubbing of stumps.
- Stripping of topsoil.



Figure 4.1: Cryptic fauna species can utilise microhabitats within vegetation that are not obvious to the untrained eye, like this threatened Broad-headed Snake (*Hoplocephalus bungaroides*) found sheltering under sandstone bushrock (Photo: Matt Consterdine, Jacobs).

Application of this Guide

This Guide is applicable where native vegetation (particularly habitat trees) is to be cleared or pruned or where bushrock or other habitat is to be removed.

Specialist input requirements

An Ecologist or licensed handler should be on site during habitat removal.

A vet or licensed handler may need to be contacted to assist with injured fauna.

Management requirements

General requirements for clearing of vegetation and removal of bushrock.

When undertaking the clearing of vegetation (particularly habitat trees) and removal of bushrock, the **Environment Manager** should ensure the following is undertaken:

- The pre-clearing process is completed before any clearing begins. See [Guide 1: Pre-clearing process](#).
- A clearing and grubbing plan is developed with reference to this Guide and [EPA's waste hierarchy](#). The requirements of the clearing and grubbing plan are communicated to site staff regularly in accordance with [G36 specification](#).
- Clearing of vegetation and/or removal of bushrock does not go beyond the approved clearing limits for the project, which must be established by a qualified surveyor in accordance with [G71 specification](#). Use exclusion zone fencing/delineation techniques to improve the visibility of clearing limits. See [Guide 2: Exclusion zones](#).
- Reference is made to [Guide 6: Weed management](#) including recommendations to undertake a weed assessment and prepare a weed management plans and scheduling clearing from areas of least weeds to areas of more weeds.



Figure 4.2: Staged habitat removal taking place for Nambucca Heads to Urunga Pacific Highway Upgrade to minimise impacts on biodiversity (Photo: Sandpiper Ecological Surveys).

- Reference is made to [Guide 9: Fauna handling](#) including recommendations to assess likely biosecurity risks and undertake necessary vehicle and machinery hygiene protocols.
- Reference is made to [Guide 10: Aquatic habitats and riparian zones](#) where clearing of vegetation and/or removal of bushrock occurs within aquatic habitats and riparian zones.
- The amount of time that cleared vegetation is kept in stockpiles prior to removal/management is limited to avoid native fauna using the stockpiled vegetation as habitat.
- The recommendations of the pre-clearing report prepared by the **Ecologist** are considered. See [Guide 1: Pre-clearing process](#).
- The unexpected threatened species finds procedure is followed if a threatened species is encountered that has not previously been identified and assessed in the environmental assessment. See the unexpected threatened species finds procedure [template](#) in [Guide 1: Pre-clearing process](#).

Clearing of woody vegetation

The **Environment Manager** should communicate the following best practice methods to the clearing contractor:

- Determine if staged clearing is required based on findings and recommendations of the pre-clearing report. If required, habitat trees and any other habitat features are to be marked (Figure 1.3) and retained during the first stage of clearing (see Figure 4.2).
- Carefully clear vegetation so as not to mix topsoil with debris and to avoid impacts to surrounding native vegetation.
- Where feasible, apply soft fall techniques to the felling of large trees with habitat values such as hollows (see Figure 4.8)
- An **Ecologist** or **licensed handler** should be on-site to supervise removal of habitat features and inspect felled/cleared habitat immediately for fauna (Figure 4.4),
- Document the selection of suitable work methods in the clearing and grubbing plan.
- Retain stumps in riparian zones and aquatic habitats to reduce the potential for bank erosion. Even dead stumps and root systems may act to reduce erosion during construction and operation periods.



Figure 4.3: Sugar Glider (*Petaurus breviceps*) rescued by an **Ecologist** during staged habitat removal on Rotary Drive, Southern Region. (Photo: Brenton Hays, TfNSW).



Figure 4.4: Checking the limbs of felled habitat with an **Ecologist** recovering a glider found in a hollow limb. (Photo: Anthony Arena, TfNSW)

- Exotic (non-native) vegetation that requires removal and disposal. Where priority weed species are to be cleared, specific management measures may be needed. See [Guide 6: Weed management](#).
- Stockpiles of cleared vegetation are kept under two metres high in accordance with RMS [Stockpile Site Management Guideline](#) (2015) (Figure 4.5).



Figure 4.5: Management of mulch tannins from the Woolgoolga to Ballina Upgrade Pacific Highway (Photo: Anthony Arena, TfNSW)

Consider secondary re-use of felled trees

Cleared native vegetation is a valuable resource both during construction activities and in rehabilitation and revegetation works. Cleared vegetation should not be disposed of off-site unless absolutely necessary. The order of priorities would be the same as in the [EPA's waste hierarchy](#).

Options for re-use include (see also Table 5.1):

- Millable timber if there is an agreement with NSW State Forests.
- Using rootballs and tree trunks for resnagging aquatic habitats and bank stabilisation.
- Augmenting habitats through the creation and placement of coarse woody debris.
- Mulching as part of revegetation activities.

See Figure 4.6 and [Guide 5: Re-use of woody debris and bushrock](#).

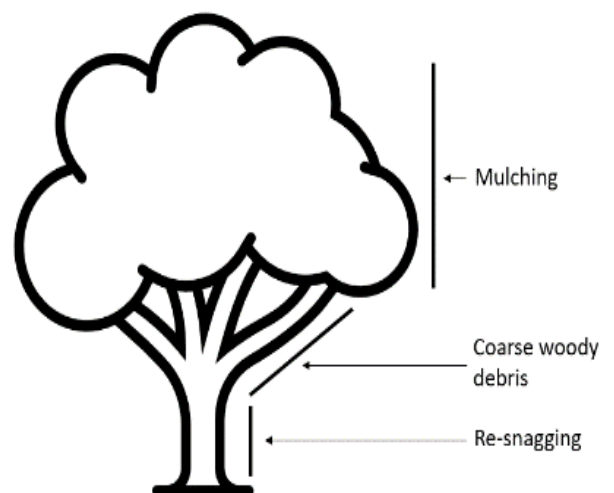

Figure 4.6: Possible allocation of tree components to different re-use purposes such as re-snagging, coarse woody debris and mulch (Source: TfNSW)

Clearing of non-woody vegetation

The **Environment Manager** should communicate the following best-practice methods to the clearing contractor:

- Non-woody vegetation (typically grasses and groundcover species) is incorporated into the stripping of topsoil to retain any organic materials and nutrients within the topsoil layer.
- In some circumstances soil may need to be treated before re-use on site e.g. acid sulfate soils (see [RTA Guideline for the Management of Acid Sulfate Materials](#)).
- Topsoil removal is carried out with suitable care such that topsoil is not mixed with subsoils, particularly in areas where topsoil is thin. Topsoil should be stockpiled separately for re-use in site rehabilitation and revegetation. See [RMS Stockpile Site Management Guideline](#) and the 'Blue Book' ([Managing urban stormwater Vol 1](#)).

Staged habitat removal

The staged habitat removal process is to be used when identified habitat (e.g. hollow-bearing trees, habitat trees or bushrock) is to be removed. Staged habitat removal minimises direct impacts on fauna by providing them with an opportunity to vacate hollows and relocate themselves away from the disturbance. The pre-clearing report identifies habitat that requires staged removal. See [Guide 1: Pre-clearing process](#).

Staged habitat removal is conducted in at least two stages, for example, clearing non-habitat trees first (Figure 4.2) followed by habitat trees and/or other habitat features (e.g. bushrock) at least 24 hours later (Figure 4.8). This staged process allows respite between the initial disturbance of the clearing and the final removal of habitat.

A **licensed handler** or **Ecologist** should be on site during habitat removal. Habitat features such as hollow bearing trees, should be inspected immediately prior to clearing using direct visual observation, pole camera or by cherry picker (Figure 4.7).

The **licensed handler** or **Ecologist** should inspect habitat features immediately after they are disturbed/felled to check for fauna (Figure 4.4). Fauna encountered during the clearing process (Figure 4.3) are handled in accordance with [Guide 9: Fauna handling](#). Where necessary, relocate fauna to pre-determined habitat identified for fauna release. These areas would have been identified as part of the pre-clearing report. See [Guide 1: Pre-clearing process](#).



Figure 4.7: Habitat tree being inspected by an arborist in a cherry picker to make sure no fauna is present before felling during the second stage of clearing (Photo: Brenton Hays, TfNSW).

Where artificial hollows are required in accordance with [Guide 8: Artificial hollows](#), the **licensed handler** or **Ecologist** should also record the number of individual hollows removed, each hollow's dimensions (e.g. entrance diameter and internal cavity size) and if there is any animal present or evidence of previous use. This information may assist in verifying the remaining artificial hollows required after clearing.

The **Environment Manager** should oversee the staged habitat removal process and ensure a **post clearing report** is prepared to document the outcomes of the process.

The staged habitat removal process is summarised in [Figure 4.9](#).



Figure 4.8: Habitat tree being carefully felled and lowered by excavators during the second stage of clearing for the Nambucca Heads to Urunga Pacific Highway Upgrade (Photo: Sandpiper Ecological Surveys).

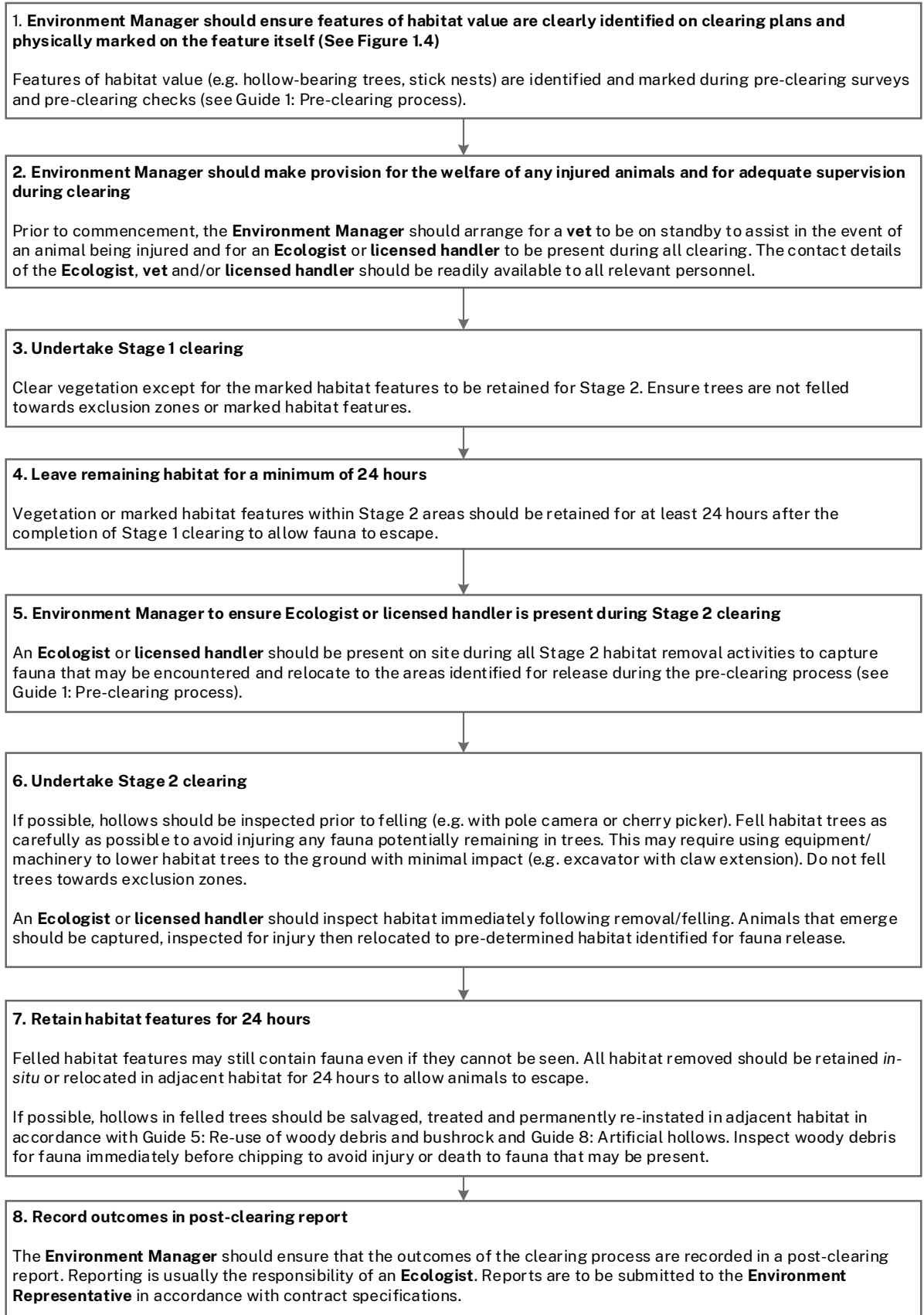

Figure 4.9: Staged habitat removal process

Managing the removal of bushrock from sites

The pre-clearing process identifies bushrock habitat (e.g. Figure 4.10) requiring management during removal and/or relocation. See [Guide 1: Pre-clearing process](#).

The **Environment Manager** should check the following is undertaken for the removal of bushrock:

- Minimise damage to the bushrock and avoid excessive soil disturbance.
- Time works to consider the seasonal requirements of fauna species and minimise any potential impact.
- A **licensed handler** or **Ecologist** is present to capture and relocate any fauna encountered in accordance with [Guide 9: Fauna handling](#).
- Follow the unexpected threatened species finds procedure if threatened species that have not been identified in the environmental assessment are detected (see the unexpected threatened species finds procedure template in [Guide 1: Pre-clearing process](#)).

See [Guide 5: Re-use of woody debris and bushrock](#) for guidance on the re-use of bushrock.



Figure 4.10: An example of sandstone bushrock habitat (Photo: Brenton Hays, TfNSW).

Reporting

The **Environment Manager** should check that the outcomes of the clearing process are recorded in a post clearing report. Reporting is usually the responsibility of an **Ecologist**. Reports are to be submitted to **Authorised Representative** as per standard contract specifications.

Include the following information in reports for vegetation clearing and bushrock removal:

- Habitat feature type and location (include unique ID and GPS coordinates).
- Number of hours between first and second stage of habitat removal.
- Fauna species present, captured and relocated including numbers.
- Release location and condition/behaviour of animal upon release.
- Fauna injured or killed.
- Number of trees / hollows removed. Record the entrance diameter and cavity size of each individual hollow removed.

Pruning

The **Environment Manager** should check that the *Australian Standard AS 4373 Pruning of amenity trees* is followed for all pruning works. Ways to minimise impact to vegetation include:

- The use of appropriate tools such as chainsaws and vehicle mounted saws. Do not use heavy machinery for pruning and trimming.
- Using the three-cut method as this avoids bark injury below the prune (Figure 4.11).
- Limbs with hollows should be lowered carefully to the ground and inspected immediately by a **licensed handler** and/or **Ecologist** is present to capture and relocate any fauna encountered.
- If possible, retain limbs bearing hollows on the tree. If a hollow limb cannot be retained then consider salvaging the hollow intact and either reinstating the hollow back into an adjacent tree or place the hollow-bearing limb in adjacent undisturbed vegetation to provide fauna habitat. See [Guide 8: Artificial hollows](#). Consider the receiving environments when placing hollow-bearing limbs in accordance with [Guide 5: Re-use of woody debris and bushrock](#).

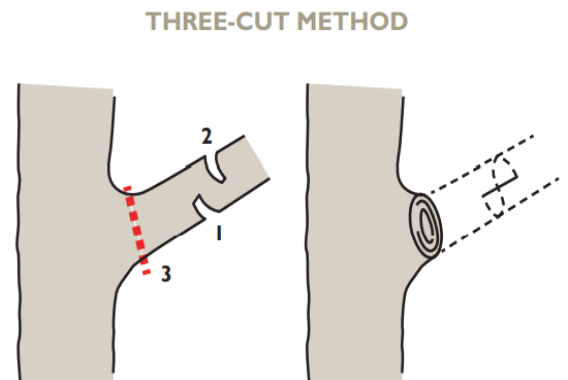

STEP 1: The under cut.

STEP 2: The upper cut to remove the branch.

STEP 3: The final cut.

Figure 4.11: The three-cut method, illustration adapted from *AS 4373 Pruning of amenity trees* (Source: TfNSW).

Supporting documents

Environmental assessment and associated supporting documents (e.g. ecological report, conditions of approval).

Environmental management plans and associated sub-plans and procedures for the works.

Australian Standard 4373 (2007) Pruning of Amenity Trees.

Australian Standard 4970 (2009) Protection of Trees on Development Sites.

Department of Planning and Environment (1999) Scientific Committee Final Determination: key threatening process – bushrock removal

Department of Planning and Environment (2003) Scientific Committee Final Determination: key threatening process - Removal of dead wood and dead trees

National Parks and Wildlife Service (1999) Threatened species information: Bushrock removal: A key threatening process

Related Transport for NSW documents and other resources

Roads and Maritime Services Stockpile Site Management Guideline (2015) (Access via the TfNSW SharePoint site 27 September 2022)

Sydney Trains EMS-06-TP-0152 Vegetation Management Scope of Work Template.DOCX

Transport for NSW QA Specification for roads G40 Clearing and Grubbing (Access via the TfNSW intranet 'CPS documents directory' page).

Transport for NSW QA Specification G36 Environment Protection for road (Access via the TfNSW intranet 'CPS documents directory' page).

Transport for NSW QA Specifications G38 Soil and Water Management for road (Access via the TfNSW intranet 'CPS documents directory' page).

Transport for NSW QA Specifications G71 Construction Surveys (Access via the TfNSW intranet 'CPS documents directory' page).

Transport for NSW Standard requirements (Works Contract) DMS-FT-425 (PDF, 745.67 KB) for rail (Access via <https://www.transport.nsw.gov.au/projects/project-delivery-requirements>)

External access to relevant Transport for NSW documentation can be requested by emailing environmentandsustainability@transport.nsw.gov.au.

Overview – Guide 4: Clearing of vegetation and removal of bushrock

Objective

The objective of this Guide is to minimise the impacts on biodiversity from loss of habitat as a result of the clearing process and specify a procedure for removal of habitat features (e.g. tree hollows and bushrock) that minimises loss and damage of native fauna and flora habitat.

Application of this Guide

This Guide is applicable where native vegetation is to be cleared or pruned and bushrock or other habitat is to be removed.

Management requirements

- The pre-clearing process should be completed before any clearing begins. See [Guide 1: Pre-clearing process](#). Check the pre-clearing report prepared by the **Ecologist** for identified habitat features and recommendations.
- Develop a clearing and grubbing plan with reference to this Guide and [EPA's waste hierarchy](#). The requirements of the clearing and grubbing plan are communicated to site staff regularly in accordance with [G36 specification](#).
- Document the selection of suitable work methods in a clearing and grubbing plan.
- Clearing of vegetation and/or removal of bushrock does not go beyond the approved clearing limits for the project.
- Follow the [unexpected threatened species finds procedure](#) if a threatened species or threatened ecological community is encountered that has not previously been identified and assessed in the environmental assessment.
- Carefully clear vegetation so as not to mix topsoil with debris and to avoid impacts to surrounding native vegetation.
- Retain stumps in riparian zones and aquatic habitats to reduce the potential for bank erosion.
- Separate woody vegetation into millable timber (if there is an agreement with NSW State Forests), secondary re-use or exotic (non-native) vegetation. See [Guide 5: Re-use of woody debris and bushrock](#) and [Guide 8: Artificial hollows](#).
- Keep stockpiles of cleared vegetation under two metres high in accordance with [RMS Stockpile Site Management Guideline \(2015\)](#).
- Non-woody vegetation (typically grasses and groundcover species) should be incorporated into the stripping of topsoil to retain any organic materials and nutrients within the topsoil layer.
- The staged habitat removal process is to be used when identified habitat (e.g. hollow-bearing trees, habitat trees or bushrock) is to be removed.

- Contact **vets** and **licensed handlers** before works start to check they are willing to assist in rescuing and treating injured animals if necessary.
- Consider the seasonal impact of clearing on species identified in the environmental assessment or pre-clearing process or that are known to occur in the area.
- A **licensed handler** or **Ecologist** should be on site during habitat removal.
- Undertake bushrock removal in a way that minimises damage to the bushrock, avoids excessive soil disturbance and avoids climatic seasons when species are utilising this resource.
- Record the outcomes of the clearing process.
- The *Australian Standard AS 4373 Pruning of amenity trees* should be followed for all pruning works.

Guide 5: Re-use of woody debris and bushrock

Background

Woody debris consists of trees and wood, whether living or dead. Woody debris is defined as pieces of wood at least 100 millimetres in diameter and at least 500 millimetres long (Gibbons *et al.* 2005). For the purposes of this Guide, woody debris relates to wood from native tree species.

Bushrock is loose rock occurring on rock or soil surfaces. Many fauna species use woody debris and bushrock for shelter, basking, to hide from predators, find food and avoid extreme weather.

Sometimes woody debris and bushrock needs to be removed from a site. When this occurs, consideration should be given to finding suitable locations for re-use of this important habitat feature in nearby areas.

‘Loss of hollow-bearing trees’ and the ‘removal of dead wood and dead trees’ are Key Threatening Processes under the *Biodiversity Conservation Act 2016* (NSW) (BC Act). Dead wood and dead trees provide essential habitat for a wide range of native fauna and are important to the functioning of many ecosystems.

‘Bushrock removal’ is also a Key Threatening Process under the BC Act. Bushrock removal results in disturbance and removal of habitat for native fauna as well as native flora that grow in rocky areas. Numerous threatened species are identified as being adversely affected by bushrock removal (e.g. reptiles and frogs).



Figure 5.1: Some cryptic species use woody debris as a habitat resource such as the Cumberland Plain Land Snail (*Meridolum corneovirens*) (Photo: Brenton Hays, TfNSW).



Figure 5.2: Large woody debris with hollows can be used as nesting habitat by mammals and birds (Photo: Sandpiper Ecological Surveys).

Objective

The objective of this Guide is to provide advice on maximising the re-use of woody debris and bushrock to minimise loss and/or damage to native flora and fauna habitats.

Application of this Guide

This Guide is applicable where:

- Native woody vegetation, including hollows and dead trees, is available to be re-used following clearing. See [Guide 8: Artificial hollows](#) for guidance on salvaging tree hollows).
- Bushrock is available to be re-used following removal.

Specialist input requirements

Use an Ecologist to determine the relocation sites and densities for placement of woody debris and bushrock.

Management requirements

General requirements for the re-use of woody debris and bushrock.

Woody debris and bushrock should be re-used on site (e.g. for habitat improvement). Where this is not possible, contact should be made with land managers within the locality including local Councils, DPI Fisheries, NSW National Parks and Wildlife Service (NPWS) and Local Land Services (LLS) to gauge level of interest in receiving and using the resource.

Table 5.1 lists some possible uses of woody debris and the size considerations. Re-use of woody debris greater than 100 millimetres in diameter (without mulching), and bushrock is encouraged.

It is important that the **Environment Manager** engages an **Ecologist** to provide advice on the re-use of woody debris and bushrock to avoid a negative impact on the receiving environment. In existing areas of high-quality habitat there may already be enough suitable hollows, fallen logs or bushrock, so adding surplus woody debris may cause a fire hazard or unnecessary disturbance.

Re-use of woody debris and bushrock off-site must be compliant with NSW EPA Resource Recovery Orders and Exemptions and *NSW Protection of the Environment Operations Act 1997*.



Figure 5.3: Hollow logs retained during clearing and stockpiled for relocation as fauna habitat on the Rankin Park to Jesmond Inner-city Bypass Project (Photo: Rebecca Vaughan, TfNSW).

Table 5.1: Possible uses of woody debris

Possible uses	Type and size (diameter)	Details
Millable timber	Logs >500mm	If there is an agreement with NSW State Forests .
River bank stabilisation	Straight and rootball logs 200-650mm	Reintroducing timber into streams to stabilise erosion, increase channel roughness and enhance stream habitat value (in consultation with DPI Fisheries and LLS). Two types of logs are typically needed to create an engineered log jam for river works: <ul style="list-style-type: none"> • Rootball logs – 350-600mm diameter, 7-8m long, native hardwood, no hollows, rootball attached. • Pin logs – 200-300mm diameter, 8m long, straight, rootball removed.
Fauna furniture	Straight solid logs 200-300mm	Used in and around underpasses for refuge poles and railings to facilitate passage off the ground for climbing animals. Refer to TfNSW Connectivity Guidelines for more information.
Replacement habitat	Solid and hollow logs >100mm	Replacement of habitat features, habitat improvement (e.g. perching sites for woodland birds, timber piles for reptiles and frogs), or erosion and sediment control. Can include a variety of sizes and shapes, including logs with branches attached.
Mulch	Debris < 100mm	Smaller woody debris can be mulched/chipped and re-used on site for revegetation and erosion/sediment control.

Relocation of woody debris and bushrock

The **Environment Manager** should support the implementation of the following best practice measures when relocating and re-using woody debris and bushrock:

1. Removal, stockpiling, transportation and relocation of woody debris and/or bushrock is carried out in a manner that minimises disturbance to native vegetation (including the canopy, shrubs, dead trees, fallen timber and groundcover species) or bushrock.
2. Do not extend the amount of clearing and grubbing to make up for mulch shortfalls.
3. The spread of any weeds or pathogens that may be in the soil is avoided when relocating woody debris and bushrock from stockpiles. Appropriate weed, disease and pest assessment needs to be undertaken prior to clearing. Refer pre-clearing survey assessment in [Guide 1: Pre-clearing process](#)
4. All off-site movement of woody debris and bushrock is undertaken in accordance with the relevant [NSW Resource Recovery Orders and Exemptions](#).
5. An **Ecologist** is engaged to provide advice on positioning woody debris and bushrock in designated relocation areas.

6. Topsoil disturbance is kept to a minimum and is not heaped up against woody debris or bushrock because of the potential to provide habitat for rabbits.
7. Woody debris is placed evenly across the site.



Figure 5.4: TfNSW provided 400 rootballs and logs felled for the Pacific Highway Upgrade for the Clarence River riparian rehabilitation project to stabilise the river banks and improve fish habitat (Photo: Soil Conservation Service).

Stockpiling of woody debris and bushrock

Bushrock, woody debris and mulch obtained from woody debris, can all be stockpiled for later re-use. The **Environment Manager** should manage stockpiles in accordance with RMS [Stockpile Site Management Guideline \(2015\)](#), TfNSW QA [Specification G36: Environmental Protection \(Management System\)](#) and TfNSW QA [Specification R178: Vegetation](#), or TfNSW Standard requirements (Works Contract) [DMS-FT-425](#) for rail.

Mulch obtained from woody debris has the potential to contain tannins. Tannins are naturally occurring plant compounds that discolour water and can increase the biological oxygen demand (BOD) in water resulting in a decrease in dissolved oxygen. Tannin generation is common in vegetation communities such as coastal floodplain forests or where high tannin generating plant species occur e.g. *Melaleuca* and *Acacia* species.



Figure 5.5: Salvaged rootball logs recovered from the Woolgoolga to Ballina Pacific Highway Upgrade Project (Photo: Anthony Arena, TfNSW).

The **Environment Manager** should consider the potential impacts of tannins leaching from stockpiled mulch and/or mulch used for erosion and sediment control or landscaping (see Figure 4.5). The **Environment Manager** should check mulch tannin management provisions are included in the Construction Environmental Management Plan (CEMP) where tannins are likely to be generated.



Figure 5.6: Salvaged logs are transported to a storage location by truck where they await re-use in waterway rehabilitation projects (Photo: LLS).

Supporting documents

Department of Environment and Climate Change (DECC)(2008) 'Blue Book' Managing urban stormwater: Soils and construction, Volume 2D: Main Road Construction.

Department of Planning and Environment (1999) Scientific Committee Final Determination: Bushrock removal - key threatening process listing.

Department of Planning and Environment (2003) Scientific Committee Final Determination: Removal of dead wood and dead trees - key threatening process listing.

Landcom (2004) 'Blue Book' Managing urban stormwater Vol 1.

NSW Environment Protection Authority (EPA) Resource Recovery Order and Exemptions

Related Transport for NSW documents and other resources

Roads and Maritime Services Stockpile Site Management Guideline (2015) (Access via the TfNSW SharePoint site)

Transport for NSW QA Specification G36 Environment Protection for road (Access via the TfNSW intranet 'CPS documents directory' page).

Transport for NSW Standard requirements (Works Contract) DMS-FT-425 (PDF, 745.67 KB) for rail (Access via <https://www.transport.nsw.gov.au/projects/project-delivery-requirements>)

Transport for NSW QA Specification R178 Vegetation (Access from the TfNSW intranet 'Roadworks specifications - TAD' page)

Transport for NSW QA Specification R179 Landscape planting (Access from the TfNSW intranet 'Roadworks specifications - TAD' page)

Transport for NSW Environment Direction Management of Tannins from Vegetation Mulch January 2012 (Access via the TfNSW intranet)

External access to relevant Transport for NSW documentation can be requested by emailing environmentandsustainability@transport.nsw.gov.au.

Overview – Guide 5: Re-use of woody debris and bushrock

Objective

The objective of this Guide is to provide advice for maximising the re-use of woody debris and bushrock to minimise loss and/or damage to native flora and fauna habitats.

Application of this Guide

This Guide is applicable where:

- Native woody vegetation, including hollows and dead trees, is available to be re-used following clearing.
- Bushrock is available to be re-used following removal.

Management requirements

- Contract specifications should state that woody debris and bushrock is to be re-used on site (e.g. for habitat improvement) where possible.
- Engage an **Ecologist** to provide advice on the re-use of woody debris and bushrock to avoid a negative impact on the receiving environment. Features to be retained and re-used can be identified during the pre-clearing process. See [Guide 1: Pre-clearing process](#).
- Ensure any re-use of woody debris and bushrock complies with NSW EPA [Resource Recovery Orders and Exemptions](#) and NSW *Protection of the Environment Operations Act 1997*.
- Prioritise on-site use of woody debris and bushrock (e.g. for habitat improvement) where possible.
- Possible on-site use includes fauna furniture including escape poles and refuge structures, replacement habitat features including hollows and perching sites, and mulch.
- Consult with relevant land managers within the locality (e.g. DPI and LLS) about possible re-use off-site such as millable timber or reintroducing timber into streams to stabilise erosion and improve habitat values.
- Manage stockpiles in accordance with RMS [Stockpile Site Management Guideline](#), TfNSW QA Specification [G36 Environment Protection](#).
- Appropriate weed, pathogen and pest assessment needs to be undertaken prior to clearing.
- Avoid the spread of any weeds or pathogens that may be in the soil when relocating woody debris and bushrock from stockpiles.
- Separate weeds from native vegetation before re-using.
- Carry out removal, stockpiling, transportation and relocation of woody debris and/or bushrock in a manner that minimises disturbance to native vegetation (including the canopy, shrubs, dead trees, fallen timber and groundcover species) or bushrock.

- Obtain **Ecologist** advice on the positioning of woody debris and bushrock in designated relocation areas. When relocating woody debris, place it evenly across the site.
- Keep topsoil disturbance to a minimum.
- Manage stockpiles in accordance with RMS Stockpile Site Management Guideline, TfNSW QA Specification G36 Environment Protection (Management System) and TfNSW R178 Vegetation or TfNSW Standard requirements (Works Contract) DMS-FT-425 for rail.
- Prepare a mulch tannin management plan for the project where tannins are likely to be generated by stockpiling woody debris.

Guide 6: Weed management

Background

A weed is a plant that requires some form of action to reduce its effects on the economy, the environment, human health and/or amenity. This can include seeds, flower heads or woody material.

Weeds are plants that may threaten agricultural productivity, have detrimental effects on the natural environment or impact on human health. Weeds may be native or introduced plant species.

Effective weed management during construction is important to limit impacts on the natural environment and adjacent landholders, meet the projects landscaping objectives and to reduce the resources required for ongoing weed management. TfNSW also has legislative imperatives to manage weeds in accordance with the *Biosecurity Act 2015*.

The *Biosecurity Act 2015* is the overarching legislation for the management of weeds, diseases and pests in NSW. The definition of 'Biosecurity Duty of care' has been interpreted as 'Any person who deals with biosecurity matter or a carrier and who knows, or ought reasonably to know, the biosecurity risk posed or likely to be posed by the biosecurity matter, carrier or dealing has a biosecurity duty to ensure that, so far as is reasonably practicable, the biosecurity risk is prevented, eliminated or minimised.' (see <https://www.dpi.nsw.gov.au/biosecurity/managing-biosecurity/the-general-biosecurity-duty>.)

Under the *Biosecurity Act 2015*, a person or authority who has responsibility for the care, control or management of a road (and roadside), must prevent, eliminate or minimise weed biosecurity risks that they know about or could reasonably be expected to know about. Therefore, the correct procedures including vehicle hygiene need to be adopted as standard practice to prevent the spread of biosecurity matter (weeds, diseases, and pests) during roadside activities.

The construction of infrastructure projects has the potential to introduce and promote the spread of weeds. The *Biosecurity Act 2015* (NSW) introduced a 'general biosecurity duty' to prevent, eliminate or minimise any biosecurity risks (including weeds) that they encounter. This means TfNSW has an obligation to implement measures to control weeds.

There are currently seven Key Threatening Processes listed under the *NSW Biodiversity Conservation Act 2016* (NSW) (BC Act) that relate to the invasion and establishment of weeds:

- Invasion and establishment of exotic vines and scramblers.
- Invasion and establishment of Scotch Broom (*Cytisus scoparius*).



Figure 6.1: Bathurst Burr (*Xanthium spinosum*) is amongst the most common and economically serious weeds in Australian agriculture (Photo: Jason Rothery, TfNSW).

- Invasion of native plant communities by Bitou Bush & Boneseed.
- Invasion of native plant communities by exotic perennial grasses.
- Invasion of native plant communities by African Olive (*Olea europaea* subsp. *cuspidata*).
- Invasion, establishment and spread of Lantana (*Lantana camara*).
- Loss and/or degradation of native plants and animal habitat by invasion of escaped garden plants, including aquatic plants.

Weeds can be classed into broad groups depending on their characteristics and impacts. The main groups of weeds are provided in Table 6.1.

Table 6.1: Classification of weeds in NSW

Classification	Description
Priority weeds	Are identified in the relevant <u>regional strategic weed management plan</u> and includes NSW and regional priority weed species and the general biosecurity duty relating to them. There are 11 regional strategic plans which outline the species that are considered priority weeds for each region. The plans then categorise weeds further into ‘prevent’, ‘eradicate’, ‘contain’ and ‘asset protection’. Priority weeds have effectively replaced the previous “noxious weed” classification in NSW.
Weeds of National Significance (WONS)	These weeds are regarded as the worst weeds in Australia because of their invasiveness, potential for spread, and economic and environmental impacts. They are detailed in the <u>Australian Weeds Strategy 2017-2027</u> .
National Environmental Alert List Weeds	Alert Weeds are non-native plant species that are in the early stages of establishment and have the potential to become a significant threat to biodiversity. They are listed on the <u>National Weeds Environmental Alert List</u> .

Weed management is most effective through an integrated approach that utilises a hierarchy of firstly prevention, then control by physical/mechanical removal, biological methods (not covered by this Guideline) and lastly chemical application (i.e. herbicides). Early detection and eradication can prevent weeds from flowering and setting seed, which could require substantial manual maintenance and control activities. Effective control may require a variety of techniques (e.g. mechanical and chemical). The suitability of certain control techniques for a site will vary depending upon the target weed species and the desired outcomes for the site. An integrated and strategic approach may sometimes require cooperation with adjacent landholders to provide adequate long-term control.

Objective

The objective of this Guide is to prevent or minimise the spread of priority weed species on all TfNSW project sites.

Application of this Guide

This Guide is applicable where TfNSW activities disturb vegetation, soil or aquatic environments.

This Guide outlines weed management requirements for weeds during construction but also provides best practice methods for weed management during maintenance activities.

Specialist input requirements

Use an **Ecologist** or **person trained in weed management and identification** to conduct a site weed assessment before works begin and assist in developing the weed management plan.

A person trained in weed management and identification would hold Australian Qualifications Framework Units AHCPMG301A (Control weeds), AHCPMG302A (Control plant pests, diseases and disorders), or AHCPMG303A (Identify plant specimens), or an equivalent qualification.



Figure 6.2: Effective early weed management during construction, and good landscape practice, can be the difference between costly ongoing management resulting in almost total plant loss (above picture) and an established weed free landscape which is self-sustaining and low maintenance (below picture) (Photos: Jason Rothery, TfNSW).

Management requirements

General requirements for weed management for projects.

The **Environment Manager** should ensure the following best practice methods for weed management are undertaken:

- Mow/slash areas infested with weeds before they seed. This may reduce the growth of new plants.
- Program works from least to most weed-infested areas.
- Clean machinery, vehicles and footwear before moving to a new location.
- Securely cover loads of weed-contaminated material to prevent weed plant material falling or blowing off vehicles.
- Manage weed material and weed-contaminated soil on site where possible (e.g through burial) and only dispose of weeds offsite in accordance with NSW EPA Resource Recovery Order and Exemptions. Where this is not possible, dispose of at a suitably licenced facility.
- Separate weeds from native vegetation where native vegetation is to be used for mulch. Do not use weeds for mulch unless it has been appropriately composted to remove the potential for regrowth/growth.
- Carry out tests on stockpiled topsoil in accordance with TfNSW NSW QA Specification R178 Vegetation.
- Send samples of topsoil being imported onto site to a National Association of Testing Authorities (NATA) approved soil laboratory to obtain assurance that it contains no weed seeds or propagules (vegetative parts of plants such as buds or offshoots that can grow into new individuals). See Guide 3: Re-establishment of native vegetation.

Site weed assessment

The **Environment Manager** should engage an **Ecologist** or **person trained in weed identification and management** to undertake a site weed assessment including:

1. Identifying and describing or mapping weed infested areas within the site and adjacent areas. A weed assessment may have been done as part of the environmental assessment. Other useful resources for the identification of weeds can be found in the Supporting documents section of this Guide. Weed identification and description/mapping will provide an understanding of the scale of weed occurrences and any associated management issues.
2. Many weeds are subject to specific biosecurity duties under the *Biosecurity Act 2015*, so it is important to identify appropriate management recommendations for any Weeds of National Significance (WoNS), National Environmental Weed Alerts, or any regional priority weeds within the site or adjacent areas. This can be done by checking the relevant regional strategic weed management plan for your region and the NSW WeedWise website. The regional strategic weed management plan identifies NSW and regional priority weed species and outlines the general biosecurity duty relating to these species.

The Weedwise website contains information to assist identifying weeds, suitable control options including herbicides registered for control by the Australian Pesticide and Veterinary Medicines Authority and links to specific management guidelines including the NSW Weed Control Handbook. Consultation with the weeds officer at the relevant local council is also recommended.

3. Identifying surrounding land uses and consultation with surrounding landholders where required.

Weed management plan

The **Environment Manager** should check a weed management plan is developed for the site based on the outcomes of a field-based weed assessment with consideration of the resources available to implement the plan. A Field Manual for surveying and mapping nationally significant weeds (Natural Heritage Trust 2004) provides guidance for developing weed management plans.

The requirements of the weed management plan would be incorporated into relevant plans for the project (e.g. landscape management plan, Construction Environmental Management Plan (CEMP) or work method statements).



Figure 6.3: The invasive plant, Sticky Nightshade (*Solanum sisymbriifolium*), infested over topsoil stockpile (Photo: Nadine Venturato, TfNSW).

The detail of the weed management plan would vary for each site but should include:

- Type and source of the weed/s.
- Weed management priorities and objectives.
- Sensitive environmental areas within or adjacent to the site.
- Location of weed-infested areas.
- Mechanical weed control methods such as slashing or mowing, as well as a range of herbicides to avoid the development of herbicide resistance.
- Timing and frequency of weed treatments to achieve effective control.
- Measures to prevent the spread of weeds.
- A monitoring program to measure the success of weed management.
- Procedures for onsite weed treatment (e.g. composting) and reuse, and/or offsite weed disposal.
- Communication strategies to improve contractor awareness of weeds and weed management.
- Any specific regulatory requirements relating to individual weed species requiring control.

Weed control methods

Weed control methods include mechanical, physical, biological and chemical techniques. The [NSW Weedwise](#) website contains over 300 weed profiles including control methods. The [NSW Weed Control Handbook](#) (DPI 2018) also provides examples of weed control methods. Biological control can present an environmentally friendly, self-sustaining and potentially cost-effective form of management. This Guideline does not cover biological control, though more information can be found in [Biological control of weeds: A practitioner's guide for south-east Australia](#) (DPI 2021).

To effectively control weeds, it is important to understand the types of weeds present and their growth cycles and flowering times.

Herbicide use

The use of herbicides is controlled in NSW by the *Pesticides Act 1999*. The **Environment Manager** should check that pesticides (including herbicides) are only applied by **personnel trained and competent in chemical use and holding the appropriate licences** (see [Licences](#)). Refer to TfNSW EMF-BP-PR-0034 Pesticide procedure (in prep.) for more information.

The application of herbicide should protect the safety of users, construction staff, neighbours, and minimise risks to the broader environment. The Pesticides section of the Environment Protection Authority website ([Pesticide use in NSW](#)) provides further information on using herbicides appropriately.

TfNSW has obligations to notify the community of proposed pesticide use (including herbicides) in accordance with the *NSW Pesticides Regulation 2017*. The [TfNSW Pesticide Use Notification Plan](#) and [Approved Pesticides List](#) are available on the Environment and Sustainability Source SharePoint site (contact your TfNSW representative for external access).

The following should be considered when using herbicides:

- **The type and dose of herbicide** – choose the right herbicide for the weed species. Refer to manufacturer's label for target weeds, application rates and 'mode of action' groups.
- **Application method** – consider the type of weed to be treated, label instructions, resources available and weed management objectives.
- **Risks** – consider associated risks with each type of application method (e.g. spray drift), surrounding land uses (e.g. schools), weather and proximity to areas of environmental sensitivity such as waterways.



Figure 6.4: Mechanical hand removal to control Balloon Cotton Bush (*Gomphocarpus physocarpus*) (Photo: Envite).



Figure 6.5: Herbicide application by foliar spraying on the Sapphire to Woolgoolga Pacific Highway Upgrade Project (Photo: Envite).

- Controls – including suitable Personal Protective Equipment (PPE).
- Timing – some control methods may not be effective at certain times of the year and weeds should be targeted when their growth cycle stage provides the best opportunity for control.
- Herbicide resistance – at sites where the same herbicide (e.g. glyphosate) has been sprayed on weeds repeatedly, the weeds may develop resistance on to that particular chemical. These weeds may no longer be controlled by that herbicide. Some examples of glyphosate resistant weeds include Annual Rye Grass (*Lolium rigidum*) and Feathertop Rhodes Grass (*Chloris virgata*). Further information on the management of glyphosate-resistant weeds is available at [CropLife Australia | Herbicide Resistant Weeds](#).
- Incidents – environmental incidents and non-conformances that occur during the application of pesticides must be managed in accordance with relevant Transport incident procedures.
- Record keeping – the *Pesticides Regulation 2017* requires that records be kept of pesticide use (unless exempt). Transport, as a public authority, must keep a copy of the records made by employees or contractors for a minimum of 3 years.

Topsoil management

Topsoil management needs to be planned to minimise the spread of weeds originating from the topsoil, while making best use of the native seed bank.

Topsoil recovered from areas of low weed infestation can be re-used onsite with treatment but should be stockpiled separately. Soil disturbance within weed-infested areas should be minimised. Refer to RMS [Stockpile Site Management Guideline \(2015\)](#), [G38 Soil and Water Management](#) and the 'Blue Book' ([Managing urban stormwater Vol 1](#)) for further guidance on stockpile management.

Management and disposal of weed-contaminated material

Weed-contaminated material (including removed vegetation and topsoil) is considered waste and must be managed (i.e. treated and/or disposed) in accordance with the relevant NSW [Resource Recovery Order and Exemptions](#).



Figure 6.6: Windrows of weed-contaminated mulch are composted onsite for the Spring Farm Parkway Stage 1 Project. Composting creates high temperatures that can destroy organic toxins, weeds seeds and plant propagules and disease organisms (Photo: Amanda Berger, TfNSW).

Weed-contaminated material can be treated and re-used onsite where the process is covered by an Environmental Protection Licence (EPL). Consider the following when planning to re-use weed-contaminated material onsite:

- Prior to mulching any vegetation, test for the presence of weeds. Determine the species of weeds present and document in the appropriate plan. Where pathogens have potential to occur, it is also recommended that soil is tested (e.g. *Phytophthora cinnamomi*) prior to commencing mulching. See [Guide 7: Pathogen management](#).
- Do not use weed material as mulch unless it has been appropriately composted to remove the potential for regrowth/growth (see Figure 6.6). A compost procedure can be developed as part of the weed management plan. After composting and a seed viability test shows no seed growth, the mulch can be used onsite subject to conformance with TfNSW [R178 Vegetation](#). If the material is to be beneficially re-used offsite, requirements (including testing) associated with the conditions of the NSW EPA [Compost Order and Exemption](#) would need to be followed.
- Topsoil from areas of high weed infestation may be disposed of onsite by burial in accordance with TfNSW [R178 Vegetation](#). Spread uncontaminated topsoil over the burial area and revegetate within seven days.

Dispose of weed-contaminated material offsite at a suitably licenced facility if unable to comply with the NSW [Resource Recovery Order and Exemptions](#). The following general measures apply:

- Place waste containing seed and vegetative material in bags or on plastic sheeting during weed removal, where practical.
- Remove all weed-contaminated plant material from the site, preferably on the same day.
- Unless treated and tested, weeds cannot be disposed to environmentally sensitive areas in accordance with the Mulch Order and Exemption.
- Offsite topsoil disposal should be avoided wherever possible.

Control of aquatic weeds

Aquatic weeds may need to be controlled when they interfere with the use of a particular aquatic environment or when there is a statutory obligation.

The best option for controlling aquatic weeds in a body of water is through integrated management which combines several techniques such as physical removal, chemical control, biological control or booms and barriers (see Figure 6.7).

For more information on aquatic weed control techniques, refer to NSW DPI [Primefact 30: Aquatic weed management in waterways and dams](#).



Figure 6.7: Salvinia (*Salvinia molesta*) treatment within Pola Creek on the Kempsey Bypass Project. Salvinia weevils were also introduced to the waterway to manage Salvinia. (Photo: Sarah Wain, TfNSW).

Supporting documents

Environmental assessment and associated supporting documents (e.g. ecological report, conditions of approval).

Environmental management plans and associated sub-plans and procedures for the works.

Ainsworth, N and Bowcher, A (2005) Guidelines for Herbicide Use near Water, Cooperative Research Centres (CRC) for Australian Weed Management, South Australia.

Department of Primary Industries (2018) New South Wales Weed Control Handbook – A guide to weed control in non-crop, aquatic and bushland situations 7th Edition.

Department of Primary Industries (DPI) NSW WeedWise

Gorham, P (2008) Primefact 30: Aquatic weed management in waterways and dams, Industry and Investment NSW.

Local Land Services 'Regional Strategic Weed Management Plan' website

NSW Environment Protection Authority Resource Recovery Order and Exemptions

The Centre for Invasive Species Solutions (2022). Weeds Australia Weed identification Tool.

Related Transport for NSW documents and resources

Sydney Trains EMS-06-GD-0070 Identification of Common Rail Corridor Weeds.pdf

Sydney Trains EMS-06-TP-0065 Weed Control Technical Specification Template.DOCX

Sydney Trains EMS-06-TP-0152 Vegetation Management Scope of Work Template.DOCX

Transport for NSW EMF-BP-FS-0006 Approved Pesticides Fact Sheet (Access via the TfNSW Environment and Sustainability Source SharePoint site)

Transport for NSW EMF-BP-PR-0034 Pesticide procedure (in prep.) (Access via the TfNSW Environment and Sustainability Source SharePoint site)

Transport for NSW EMF-BP-PS-0095 Pesticide Use Notification Plan (Access via the TfNSW Environment and Sustainability Source SharePoint site)

Transport for NSW QA Specification R178 Vegetation and R179 Landscape Planting (Access via the TfNSW intranet 'Roadworks specifications – TAD' page)

External access to relevant Transport for NSW documentation can be requested by emailing environmentandsustainability@transport.nsw.gov.au.

Overview – Guide 6: Weed management

Objective

The objective of this Guide is to prevent or minimise the spread of priority weed species on all TfNSW project sites.

Application of this Guide

This Guide is applicable where Transport activities disturb vegetation, soil or aquatic environments.

Management requirements

- Use an **Ecologist** or person trained in weed management and identification to undertake a site weed assessment to identify and describe or map weed infested areas within the site and adjacent areas prior to clearing.
- Identify and manage any priority weeds, Weeds of National Significance (WONS) and National Weeds Environmental Alert List weeds.
- Priority weeds located within the site or adjacent areas in consultation with the weeds officer at the relevant local council.
- Identify surrounding land uses and consult with surrounding landholders where required.
- Develop a weed management plan for the site.
- The application of herbicide should protect the safety of users and other people and minimise risks to the broader environment.
- Transport has obligations to notify the community of proposed pesticide use (including herbicides) in accordance with the NSW Pesticides Regulation 2017 (see TfNSW [Pesticide Use Notification Plan](#) and [Approved Pesticide Fact Sheet](#)).
- Use signs to delineate areas that are infested with weeds to limit access by personnel and vehicles.
- Use mechanical weed-control methods such as slashing or mowing, as well as a range of herbicides to avoid the development of herbicide resistance (e.g. glyphosate resistance).
- Mow/slash areas infested with weeds before they seed. This may reduce the propagation of new plants.
- Program works from least to most weed-infested areas.
- Clean machinery, vehicles and footwear before moving to a new location.
- Securely cover loads of weed-contaminated material to prevent weed plant material falling or blowing off vehicles.
- Prioritise onsite disposal of weeds including through burial.
- Do not use weeds for mulch unless it has been appropriately composted to remove the potential for regrowth/growth.
- Send samples of topsoil being imported onto site to a **National Association of Testing Authorities (NATA) approved soil laboratory** to obtain assurance it contains no weed seeds or

propagules (vegetative parts of plants such as buds or offshoots that can grow into new individuals).

- Minimise soil disturbance within weed infested areas. Topsoil recovered from areas of low weed infestation can be re-used onsite with treatment (composting) but should be stockpiled separately. After composting and a seed viability test shows no seed growth, the mulch can be used onsite subject to conformance with TfNSW [R178 Vegetation](#).
- For more information on aquatic weed control techniques, refer to NSW DPI [Primefact 30: Aquatic weed management in waterways and dams](#).

Guide 7: Pathogen management

Background

Pathogens are agents that cause disease in flora and fauna and are usually living microorganisms such as a bacterium, virus, or fungus. Some pathogens are restricted to certain areas, and others are widespread across Australia. The severity of infection can also differ between areas.

Pathogens can be spread on footwear, infested plant material, vehicles and machinery, particularly during wet weather or in wet conditions. Strict precautions are necessary to prevent the spread of some pathogens. Some pathogens cannot be eradicated from infected sites so controlling their introduction and spread is a high priority.

Several pathogens in NSW have the potential to impact on the environment and biodiversity. These may be introduced and spread during the construction of transport infrastructure and include:

- Phytophthora (*Phytophthora cinnamomi*).
- Chytrid fungus (*Batrachochytrium dendrobatidis*).
- Myrtle rust (*Uredo rangelli*).
- Fusarium wilt / Panama disease (*Fusarium oxysporum*).

Phytophthora is a soil-borne fungus that causes tree death (dieback) where infestation occurs (see Figure 7.1). Phytophthora attacks the roots of a wide range of native plant species causing them to rot. 'Infection of native plants by Phytophthora' is listed as a Key Threatening Process under the Commonwealth *Environment Protection and Biodiversity Conservation Act 1999* (EPBC Act) and NSW *Biodiversity Conservation Act 2016* (BC Act). Spores can be dispersed over relatively large distances by surface and sub-surface water flows. Infected soil/root material may be dispersed by vehicles (e.g. earthmoving equipment) animals and bushwalkers.



Figure 7.1: Dieback in Grass-tree (*Xanthorrhoea australis*) with yellowing foliage (centre), a dead plant (left), and a healthy individual (right) (Photo: K McDougall, EHG).

Chytridiomycosis (chytrid) is an infectious disease that affects amphibians worldwide. The disease is caused by the fungus *Batrachochytrium dendrobatidis*. In Australia, chytrid has impacted native frog species, causing the extinction of one species of frog and suspected to have caused the extinction of three others. 'Infection of frogs by amphibian chytrid fungus causing the disease chytridiomycosis' is listed as a *Key Threatening Process* under the BC Act and EPBC Act.

Chytrid is a water-borne fungus that may be spread during construction activities as a result of handling frogs or through cross contamination of water bodies.



Figure 7.2: A Great Barred Frog (*Mixophyes fasciolatus*) displaying symptoms of chytrid such as lethargy, emaciation, half-closed eyes and accumulation of sloughed skin over the body (Photo: Lee Berger, CSIRO).



Figure 7.3: A Common Green Tree Frog (*Litoria caerulea*) with chytrid symptoms, including redness on the underside of the body and leg (Photo: K Gillet, EHG).

Myrtle rust is a plant disease caused by the introduced fungus *Uredo rangelli*. It was first detected in NSW in April 2010 and has spread across the eastern Australian landscape in bushland reserves, home gardens, commercial operations and amenity settings such as parks and street plantings. Myrtle rust can now be found in New South Wales, Victoria, Queensland, Tasmania and on the Tiwi Islands in the Northern Territory.



Figure 7.4: Leaves of a threatened Scrub Turpentine (*Rhodamnia rubescens*) showing Myrtle rust pustules (Photos: Brenton Hays, TfNSW).

Myrtle rust attacks the young leaves, shoot tips and stems of Myrtaceous plants (e.g. Bottle Brush, Tea Tree, Lilly Pilly and Turpentine) eventually killing the plant. Myrtle rust is an air-borne fungus that may be spread by moving infected plant material, contaminated clothing (especially hats), equipment and vehicles. The 'Introduction and establishment of Exotic Rust Fungi of the order

Pucciniales pathogenic on plants of the family *Myrtaceae*' is listed as a *Key Threatening Process* under the BC Act. Myrtle rust is included in this Key Threatening Process.

Fusarium wilt (or Panama disease) is an introduced plant disease caused by the fungus *Fusarium oxysporum*. It is widespread in banana plantations in the Northern Rivers region of NSW, but is also known from a few plantations in Coffs Harbour and Woolgoolga.

Fusarium wilt is spread when spores are moved in soil by water, workers, vehicles, animals or movement of infected plant material. Plants affected by Fusarium wilt show unusual patterns of frond (leaves) death and will eventually die. There is no cure or control mechanism but it can be kept out of a plantation through best-practice hygiene protocols.



Figure 7.5: Banana plantations near Coffs Harbour showing yellow leaves, a visual symptom of Panama Disease (Photos: QLD Department of Agricultural and Fisheries).

Objective

The objective of this Guide is to provide guidance for preventing the introduction and/or spread of disease-causing agents such as bacteria and fungi.

Application of this Guide

This Guide is applicable wherever pathogens are known or suspected to occur on or adjacent to the construction site.

Specialist input requirements

Testing from a National Association of Testing Authorities (NATA) approved laboratory may be required to confirm the presence of pathogens in the soil and/or water.

Testing by DPI [Plant health diagnostic services](#) may be required for suspected cases of plant pathogens.

[Reporting a pest or disease or other biosecurity concern](#) is required in certain situations in NSW.

Advice from Department of Primary Industries (DPI) or the Environment and Heritage Group (E&HG) regarding the most practical hygiene management measures may be required if pathogens are present.

Management requirements

The **Environment Manager** should consider the potential for pathogens to occur on site or in the area at the earliest possible stage. This includes considering the potential risk for the project to contribute to the spread of pathogens.

Testing should be undertaken where there is a high risk that pathogens could be present. If testing demonstrates that the pathogen is not present, management measures should focus on the potential for introducing pathogens from offsite. The management required for each project will depend on the presence of pathogens and identification of high-risk areas (e.g. amphibian breeding habitat).

Pathogen management is ongoing throughout the period in which works are being carried out.

Industry response to pathogens and quarantine areas is dynamic. The **Environment Manager** should check the DPI website for the most up-to-date hygiene protocols for each pathogen and for the most recent locations of contamination. [Table 7.1](#) and [Table 7.2](#) provide best-practice hygiene protocols to help prevent the introduction and/or spread of pathogens.



Figure 7.6: Vehicle wash down to prevent the spread of pathogens at Bulahdelah, Hunter Region (Photo: Angie Radford, TfNSW).

Where pathogens have been identified or are considered likely to occur, the **Environment Manager** should check the risk of spreading pathogens and the mitigation measures required on site are regularly communicated to staff and contractors e.g. during inductions and toolbox talks.

Machinery, plant and equipment hygiene protocol

Before using machinery, plant or equipment near or within areas of bushland or waterways, prepare a machinery, plant and equipment hygiene protocols and consider the following controls.

Before beginning the project:

- Know where biosecurity matter infestations occur in your local area – this would involve contacting your local Council Weeds Officer and checking DPI information Managing Biosecurity in NSW. Previous local weed management plans or protocols may also be a good source of information.
- Identify any planned activities with the potential to spread biosecurity matter – this includes movement of people, plant and machinery to/from/through infested areas.
- Ensure vehicles, plant and machinery are clean prior to accepting on site.

As a standard, all machinery movements should adhere to designated access tracks and areas identified in project documentation. Machinery including vehicles should not park in known infested areas.

Where contact with biosecurity matter is unavoidable, follow the below vehicle hygiene ‘clean down’ process:

- Use a designated clean bay which should be monitored for weed emergence and treated regularly.
- Clean all soil and plant material from vehicle (inside and out), equipment and clothing.
- Brush off/vacuum/use a blower to clean inside of vehicle and under the hood.
- Clean from top of the vehicle down.
- Remove any seed and plant material from clothing.
- Use a pressure washer, where available, to remove debris from vehicle, paying particular attention to high-risk areas that have been in contact with weeds such as tyres.
- If adequate cleaning facilities are unavailable onsite, clean the vehicle at a suitable wash-down facility before proceeding to another site.



Figure 7.7: Target areas for cleaning to remove soil, seeds and plant parts (Source: EFS-33 Vehicle hygiene)

Table 7.1: Best practice hygiene protocols to prevent the introduction or spread of Phytophthora and Chytrid pathogens

Best practice hygiene protocols	Phytophthora (<i>Phytophthora cinnamomi</i>)	Chytrid (<i>Batrachochytrium dendrobatidis</i>)
When is testing recommended?	<ul style="list-style-type: none"> Where there is evidence of disease Where works are within or close to the Phytophthora known distribution (refer to the SEED website or TfNSW GeoHub for mapping). 	<ul style="list-style-type: none"> Where sick frogs are evident Where a frog relocation mitigation measure is being implemented
What does testing involve?	<ul style="list-style-type: none"> Soil test by a NATA-approved laboratory 	<ul style="list-style-type: none"> Water test by a NATA-approved laboratory
Work programs	<ul style="list-style-type: none"> Minimise work during excessively wet or muddy conditions. Programming of works should always move from uninfected areas to infected areas. 	<ul style="list-style-type: none"> Minimise work during excessively wet or muddy conditions. Programming of works should always move from uninfected areas to infected areas.
Restrict access	<ul style="list-style-type: none"> Set up exclusion zones with appropriate delineation and signage to restrict access into contaminated areas. 	<ul style="list-style-type: none"> Set up exclusion zones with appropriate delineation and signage to restrict access into contaminated areas.
Inductions	<ul style="list-style-type: none"> All personnel (including visitors) to be inducted on Phytophthora management measures for the site. 	<ul style="list-style-type: none"> All personnel (including visitors) to be inducted on chytrid management measures for the site.
Vehicle and machinery	<ul style="list-style-type: none"> Provide vehicle and machinery wash down facility and ensure washdown wastewater is contained. Disinfect vehicle and machinery using one of the disinfectant options in Table 7 of DPIE Hygiene Guidelines. Disinfection is required before entering the site where phytophthora is not thought to be present and <u>before</u> and <u>after</u> leaving a site where phytophthora may be or is present. 	<ul style="list-style-type: none"> Provide vehicle and machinery wash-down facility and ensure washdown wastewater is contained. Disinfect vehicle and machinery using one of the disinfectant options in Table 7 of DPIE Hygiene Guidelines. Restrict vehicles to designated tracks, trails and parking areas. Provide parking and turn-around points on hard, well-drained surfaces.

Best practice hygiene protocols	Phytophthora (<i>Phytophthora cinnamomi</i>)	Chytrid (<i>Batrachochytrium dendrobatidis</i>)
	<ul style="list-style-type: none"> Restrict vehicles to designated tracks, trails and parking areas. Provide parking and turn-around points on hard, well-drained surfaces. 	
Personnel and equipment	<ul style="list-style-type: none"> Provide boot wash-down facility. Disinfect footwear and equipment using one of the disinfectant options in Table 7 of <u>DPIE Hygiene Guidelines</u>. Restrict personnel to designated tracks and trails. 	<ul style="list-style-type: none"> Provide boot wash-down facility. Disinfect footwear and equipment using one of the disinfectant options in Table 7 of <u>DPIE Hygiene Guidelines</u>. Disinfect hands or change gloves between the handling of individual frogs and between each site. Only handle frogs when necessary. Use the 'one-bag-one-frog' approach.
New material	<ul style="list-style-type: none"> Use a certified supply of plants and soil that is disease-free. 	<ul style="list-style-type: none"> N/A
Disposing of material	<ul style="list-style-type: none"> Retain all potentially affected materials within the contaminated area. Separate stockpiles of mulch, topsoil and fill material to avoid potential contamination and spread. Avoid moving affected mulch or topsoil to disease free areas of the site. Affected material transferred off site must comply with the <u>NSW Resource Recovery Order and Exemptions</u> 	<ul style="list-style-type: none"> To avoid cross contamination, avoid transferring water from waterbodies where chytrid has been found. Avoid using chytrid infected water in construction activities

Table 7.2: Best practice hygiene protocols to prevent the introduction or spread of Fusarium wilt and Myrtle rust pathogens

Best practice hygiene protocols	Fusarium wilt / Panama disease (<i>Fusarium oxysporum</i>)	Myrtle rust (<i>Uredo rangelli</i>)
When testing is recommended?	<ul style="list-style-type: none"> Any works in former and existing banana plantations Contact DPI before carrying out the works in former banana plantations to see if and where Fusarium wilt is present. 	<ul style="list-style-type: none"> Where visual inspection suggests myrtle rust may present
What does testing involve?	<ul style="list-style-type: none"> Sample potentially infected plants and send to <u>DPI Plant health diagnostic services</u> 	<ul style="list-style-type: none"> Sample potentially infected plants and send to <u>DPI Plant health diagnostic services</u>
Work programs	<ul style="list-style-type: none"> An Environmental Work Method Statement (EWMS) needs to be developed and reviewed by the relevant TfNSW Environment Manager Project Manager. Avoid earthwork during heavy rainfall or immediately after extended rainfall. Programming of works should always move from uninfected areas to infected areas. 	<ul style="list-style-type: none"> Programming of works should always move from uninfected areas to infected areas.
Restrict access	<ul style="list-style-type: none"> Set up exclusion zones with fencing and signage to restrict access into contaminated areas. 	<ul style="list-style-type: none"> Set up exclusion zones with fencing and signage to restrict access into contaminated areas.
Inductions	<ul style="list-style-type: none"> All personnel (including visitors) to be inducted on Fusarium wilt management measures for the site. 	<ul style="list-style-type: none"> All personnel (including visitors) to be inducted on Myrtle rust management measures for the site.
Vehicle and machinery	<ul style="list-style-type: none"> Provide vehicle wash-down facility and ensure washdown wastewater is contained. Ensure all vehicles and equipment are clean of soil, vegetation, excess oil and grease, and any other potential contaminants and have been decontaminated from the previous use prior to mobilising to site. 	<ul style="list-style-type: none"> Provide vehicle wash down facility and ensure washdown wastewater is contained. Disinfect vehicle and machinery using one of the disinfectant options in Table 7 of <u>DPIE Hygiene Guidelines</u>. Restrict vehicles to designated tracks, trails and parking areas. For medium to long-term projects, install a concrete

Best practice hygiene protocols	Fusarium wilt / Panama disease (<i>Fusarium oxysporum</i>)	Myrtle rust (<i>Uredo rangelli</i>)
	<ul style="list-style-type: none"> All vehicles and machinery are to be decontaminated prior to leaving the site. A broad-spectrum disinfectant containing 120g/L of didecyldimethyl ammonium chloride, such as Path-X™ Agriculture. Discuss proposed use of any alternative disinfectants with the Authorised Representative. For medium to long-term projects, install a concrete wash-down bay which will capture the water in a trench or bunded area. Water used for wash downs must not be used for dust control. 	<p>wash down bay which will capture the water in a trench or bunded area. Water used for wash downs must not be used for dust control.</p>
Personnel and equipment	<ul style="list-style-type: none"> Provide boot wash-down facility. Remove mud/dirt from footwear and equipment All personnel are to be decontaminated prior to leaving the site. A broad-spectrum disinfectant containing 120g/L of didecyldimethyl ammonium chloride, such as Path-X™ Agriculture. Discuss proposed use of any alternative disinfectants with the TfNSW Environment Manager. 	<ul style="list-style-type: none"> Personnel working in an infected site should shower and launder clothes (especially hats) before moving to another bushland site. Provide boot wash-down facility. Disinfect footwear and equipment using one of the disinfectant options in Table 7 of DPIE Hygiene Guidelines
New material	<ul style="list-style-type: none"> New soil being brought onto the site is disease-free. 	<ul style="list-style-type: none"> Use a certified supply of plants and soil that is disease-free. The Australian Nursery Industry Myrtle rust management plan V3 provides best-practice Myrtle rust management that is to be expected from suppliers.
Disposing of material	<ul style="list-style-type: none"> Run-off water must not be used for dust control or irrigation and it is not to be released. 	<ul style="list-style-type: none"> Plant material should be buried on site if possible.

Best practice hygiene protocols	Fusarium wilt / Panama disease (<i>Fusarium oxysporum</i>)	Myrtle rust (<i>Uredo rangelli</i>)
	<ul style="list-style-type: none"> • Topsoil from potentially infected plantations must only be stockpiled and used within contaminated areas of the plantation. 	<ul style="list-style-type: none"> • Do not dispose of waste at another bushland site. • Buried material sites must be mapped to prevent re-exposure, especially if located near utility easements. • If material cannot be buried advice should be sought from DPI.

Examples of pathogen management on TfNSW projects

The following photos provide best practice examples of hygiene protocols applied to TfNSW projects across NSW. This includes handheld boot and vehicle wash down, truck wash down bays, secure disposal of cleared vegetation and disposable suits for personnel on high-risk sites.



Figure 7.8: Soil solarisation to control soilborne pathogens using high temperatures on the Woolgoolga to Ballina Upgrade of the Pacific Highway) (Photo: Anthony Arena, TfNSW).



Figure 7.9: Wheel wash bay used at Tempe Reserve during construction of the Airport Link, Sydney Region. Most trucks drove through the wheel wash, but some vehicles needed to be scrubbed so that materials were not transported from site. The water depth was approximately 400mm, with a cattle grate underwater for solids to settle under (Photo: Leigh Trevitt, TfNSW).



Figure 7.10: Boot wash down to prevent the spread of the Pathogen chytrid on shoes on the Sapphire to Woolgoolga project, Northern Region. (Photo: Josie Stokes, TfNSW).



Figure 7.11: Removed vegetation was securely wrapped in black plastic bags before disposal to prevent the spread of the pathogen Myrtle rust on the M2 Upgrade, Sydney Region (Photo: Nicholas Francesconi, TfNSW).



Figure 7.12: Disposable suits worn on the M2 Upgrade (Sydney Region) following Myrtle rust identification adjacent to Blue Gum High Forest critically endangered ecological community (CEEC). This level of hygiene is recommended when working in Myrtle rust sites that are adjacent to highly sensitive ecological areas (Photo: Donald Cheong, TfNSW).

Supporting documents

Environmental assessment and associated supporting documents (e.g. ecological report, conditions of approval).

Environmental management plans and associated sub-plans and procedures for the works.

Commonwealth of Australia 'Arrive Clean, Leave Clean' 2015

Department of Climate Change Energy Environment and Water (2018) Threat abatement plan for disease in natural ecosystems caused by *Phytophthora cinnamomi*

Department of Climate Change Energy Environment and Water (2018) Infection of amphibians with chytrid fungus resulting in chytridiomycosis (2016)

Department of Planning, Industry and Environment (2020) Hygiene guidelines for wildlife: Protocols to protect priority biodiversity areas in NSW from *Phytophthora cinnamomi*, myrtle rust, amphibian chytrid fungus and invasive plants.

Department of Primary Industries (2015) PrimeFact 1417 Myrtle Rust.

Department of Primary Industries Report a pest or disease, or other biosecurity concern (nsw.gov.au)

McDonald, J (2013, updated 10/02/2022) Australian Nursery Industry Myrtle Rust (*Uredo rangelli*) Management Plan V3, Nursery and Garden Industry Australia, Sydney.

Newley, P (August 2010) PrimeFacts 1029 - Panama disease in bananas, Department of Primary Industries.

O'Gara, E, Howard, K, Wilson, B and Hardy, J (2005) Management of *Phytophthora cinnamomi* for Biodiversity Conservation in Australia: Part 2 National Best Practice Guidelines, A report funded by the Commonwealth Government Department of the Environment and Heritage by the Centre for *Phytophthora* Science and Management, Murdoch University, Western Australia.

Suddaby, T and Liew, E (2008) Best Practice Management Guidelines for *Phytophthora cinnamomi* within the Sydney Metropolitan Catchment Management Authority Area, Royal Botanic Gardens Trust, Sydney.

Related Transport for NSW documents and resources:

Ferrovial Gamuda Joint Venture (2023) Coffs Harbour Bypass Panama Disease Control Management Plan (Available to download from the Pacific Highway Upgrade website <https://www.pacifichighway.nsw.gov.au/document-library/panama-disease-control-management-plan>).

Transport for NSW Maintenance & Delivery Online Management System, Environmental fact sheet – EFS- 33 Vehicle Hygiene (accessible from TfNSW website)

External access to relevant Transport for NSW documentation can be requested by emailing environmentandsustainability@transport.nsw.gov.au.

Overview – Guide 7: Pathogen management

Objective

The objective of this Guide is to provide guidance for preventing the introduction and/or spread of disease causing agents such as bacteria and fungi.

Application of this Guide

This Guide is applicable wherever pathogens are known or suspected to occur on or adjacent to construction sites.

Management requirements

- Consideration for the potential for pathogens on site or in the area should be given at an early stage (e.g. in the environmental assessment).
- Pathogen management is ongoing throughout the period in which works are being carried out.
- Check the Department of Primary Industries (DPI) website (<https://www.dpi.nsw.gov.au/>) for the most up-to-date hygiene protocols for each pathogen and for the most recent locations of contamination.
- The risk of spreading pathogens and the mitigation measures required on site are regularly communicated to staff and contractors e.g. during inductions and toolbox talks.
- Advice from DPI or the NSW Department of Climate Change, Energy, the Environment and Water (DCCEEW) regarding the most practical hygiene management measures may be required if pathogens are present.
- Sample potentially infected plants and send to DPI Plant health diagnostic services.
- Programming of works should move from uninfected areas to infected areas.
- Vehicles and footwear are free of soil before entering or exiting the site (i.e. directed to wash down area before entering or exiting the site).
- Provide vehicle and boot wash down facilities.
- Testing from a National Association of Testing Authorities (NATA) approved laboratory may be required to confirm the presence of pathogens in the soil and/or water where the environmental impact assessment has identified sensitive habitats nearby.
- Set up exclusion zones with fencing and signage to restrict access into contaminated areas.
- Restrict vehicles to designated tracks, trails and parking areas.

Guide 8: Artificial hollows

Background

Artificial hollows can be used to provide supplementary habitat for certain hollow-dependent fauna where natural hollows have been removed. When designed, built and installed correctly, artificial hollows can provide an effective short to medium term alternative to natural hollow habitat. Hollows exist in both live and dead trees.

Artificial hollows would not provide a permanent offset for the loss of natural hollows unless they are delivered on land managed for conservation purposes (such as a biodiversity stewardship agreement or national park) and there is a commitment to in-perpetuity maintenance of the artificial hollows.

Tree hollows are a critical resource for many fauna species providing shelter and nesting sites. In NSW, around 170 land-based vertebrate species (20 per cent) are reliant on tree hollows for shelter and nests (Gibbons and Lindenmayer 1997, Gibbons and Lindenmayer 2002, NSW Environment Protection Authority 2021). Of these, around 25 per cent are listed as threatened under the *Biodiversity Conservation Act 2016* (NSW Threatened Species Scientific Committee 2007). Due to the combined effects of land clearing and inappropriate fire regimes, the 'Loss of hollow-bearing trees' is listed as a Key Threatening Process under the NSW *Biodiversity Conservation Act 2016*.

The slow natural development of hollows has led to the use of artificial hollows to provide temporary breeding and shelter habitat for hollow-dependant fauna where natural hollows have been removed. Artificial hollows can be created by a range of techniques.

Nest boxes are one method that aim to mimic the habitat values of a natural tree hollow and have been used in Australia for many years to provide habitat for fauna. More recently, new techniques including carved hollows, salvaged natural hollows and insulated modular nest boxes are being trialled which may offer benefits in terms of longevity, constructability and suitability for fauna.

Objective

The objective of this Guide is to provide a resource for designing all components of mitigation to address the impact of natural hollow loss from TfNSW projects.

Application of this Guide

This Guide is applicable to any project where hollow-bearing trees (both live and dead) are to be removed and artificial hollows are required to mitigate habitat loss. For projects with hollow replacement requirements under the [Transport Biodiversity Policy 2022](#), this Guide should be read in conjunction with the [EMF-BD-GD-0129 TfNSW Tree and Hollow Replacement Guidelines](#). Figure 8.1 illustrates the decision process and key steps in developing and executing mitigation for natural hollow loss.

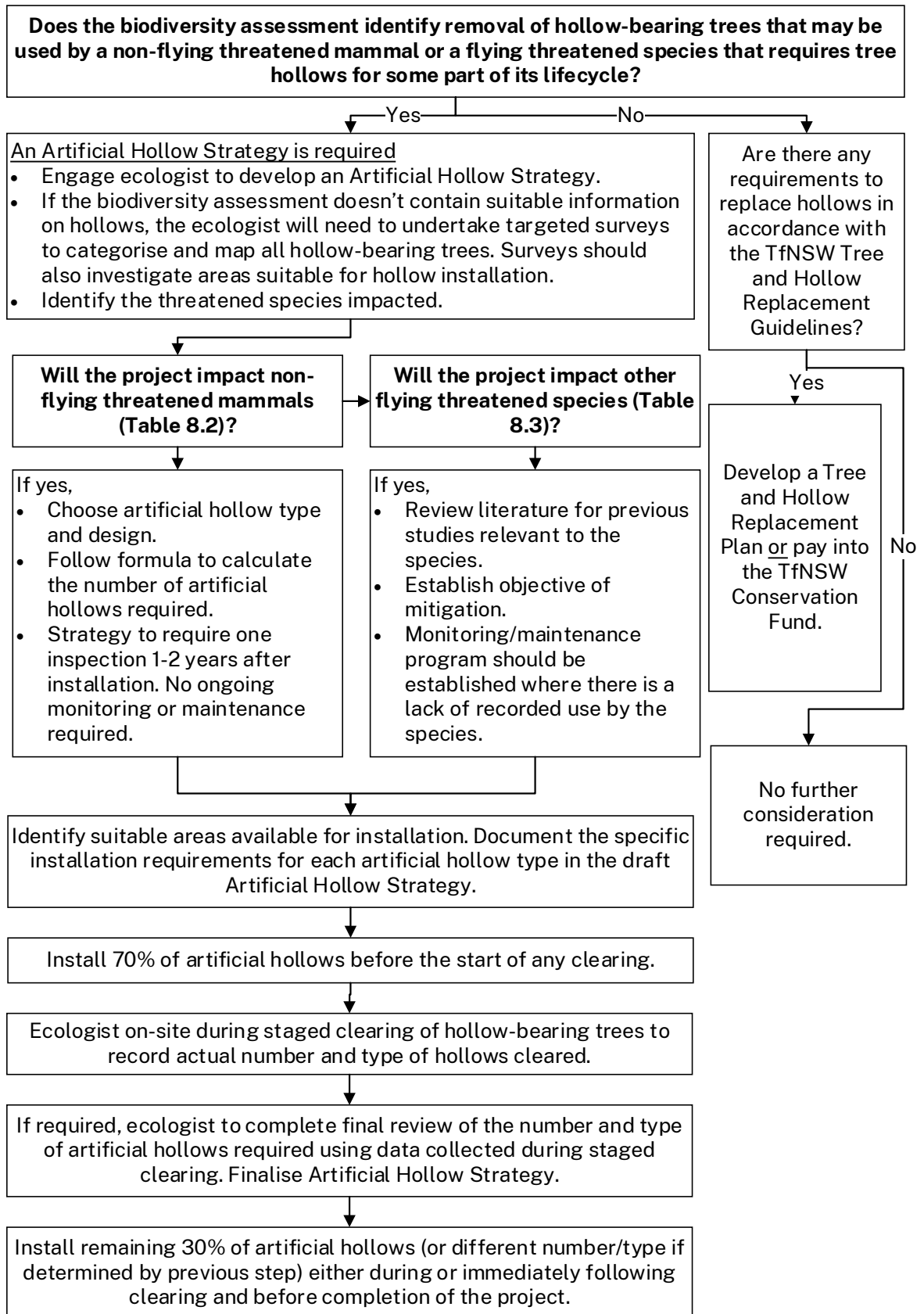

Figure 8.1: Decision workflow and key steps for mitigation of natural hollow loss

Specialist input requirements

Specialist input may be required from a suitably qualified and experienced **Ecologist** and a suitably **qualified arborist (Australian Qualifications Framework (AQF) Level 5)** for various tasks during hollow mitigation development and implementation (**Table 8.1**).

Table 8.1 Specialist input requirements

Task	Specialist input requirements
Targeted hollow survey	Ecologist role: Where environmental impact assessment documentation does not quantify hollow impacts an Ecologist may be required to undertake targeted surveys to inform the development of an Artificial Hollow Strategy.
Staged clearing assessment of hollows removed	Ecologist role: Can be conducted during staged clearing in accordance with <u>Guide 4: Clearing of vegetation and removal of bushrock</u> to verify hollow impacts. Note installation of 70 per cent of artificial hollows required prior to commencement of clearing of that stage.
Artificial Hollow Strategy	Ecologist role: Artificial Hollow Strategy should be written by an Ecologist . AQF Level 5 arborist role: Consultation may be required if Artificial Hollow Strategy involves carved or salvaged hollows.
Nest box installation	Ecologist role: Supervision on-site recommended.
Carved hollow creation	Ecologist role: Supervision on-site recommended. AQF Level 5 arborist role: Due to risk of impact on tree health, it is recommended carved hollows are created only under the supervision of an AQF level 5 arborist with experience in hollow creation. Arborist is expected to provide advice regarding measures to minimise impact of carving on tree health.
Salvaged hollow works	Ecologist role: Supervision on-site recommended. AQF Level 5 arborist role: Salvaged hollow removal and installation should be supervised by an AQF level 5 arborist . Arborist must approve host tree and installation method to have safety risks addressed.

Management requirements

The **Environment Manager** should check if the environmental assessment for the project contains safeguards requiring artificial hollows to mitigate habitat loss. Where artificial hollows are required, the **Environment Manager** should then determine if an Artificial Hollow Strategy is appropriate.

Projects that need to remove natural hollows that are likely to be used by a threatened hollow-dependant non-flying mammal (Table 8.2) and/or a threatened flying species (Table 8.3) should engage a suitably qualified **Ecologist** to develop an Artificial Hollow Strategy.

Other projects that need to replace hollows where there is a low likelihood of use by a threatened hollow-dependant species can document the mitigation in a Tree and Hollow Replacement Plan (see TfNSW [Tree and Hollow Replacement Guidelines](#)).

Artificial Hollow Strategy

An **Artificial Hollow Strategy** is a document that would detail the type, design, number, placement and monitoring requirements of artificial hollows. An **Artificial Hollow Strategy** should contain the following information:

- Objectives of mitigation.
- Target species and the design of artificial hollows available.
- The size, type and quantity of natural tree hollows to be removed.
- Assessment of the number and type of artificial hollows required.
- Maps of existing natural hollows and planned artificial hollow installation locations.
- Installation and access considerations.
- Monitoring and reporting requirements.

The following sections provide guidance for developing some of the components of an **Artificial Hollow Strategy**.

Surveys and data

The information required to develop an **Artificial Hollow Strategy** can be collected during the environmental impact assessment. However, where this information is insufficient, targeted surveys may be required to quantify and categorise the hollows removed. Surveys should aim to collect as much detail about the impacted hollows as possible. This includes the location and number of hollows on the tree, entry size (mm), aspect and orientation, lip / bark thickness, presence of perch, distance of chamber from entry, number of entry points and chamber dimensions, and whether the hollows appear to be suitable or have evidence of usage.

The **Artificial Hollow Strategy** will also need to identify suitable areas of vegetation for hollow installation, which may depend on land ownership, the density of existing natural hollows and type/number of artificial hollows required. Suitable areas should be broadly identified with more specific installation and placement requirements that allows for flexibility on the ground. Where carved hollows are proposed, a pre-installation survey should be undertaken by a suitably and experienced **Ecologist** and a suitably **qualified arborist** (AQF5). This survey would aim to identify and mark specific trees suitable for carving, including the cavity size that can be created (determined by **AQF5 arborist**).

Design of artificial hollows

The **Environment Manager** should engage a suitably qualified **Ecologist** to certify that artificial hollows are designed and built to suit the target species in accordance with the **Artificial Hollow Strategy**. The following sections describe the main design features of the three primary artificial hollow types.

Nest boxes

Nest boxes are a human-made structure designed to mimic a natural hollow. Design and construction of nest boxes varies widely, with differences driven by suitability (for target species) and longevity.

Nest boxes should be sourced from a reputable manufacturer with demonstrated experience in creating quality products. Alternative suppliers that do not specialise in nest box manufacturing may be considered, however the **Environment Manager** should check that design meets the requirements of the strategy and construction follows industry best practice (Biodiversity Conservation Trust 2020).

Studies have shown that traditional nest boxes have poor thermal insulation and often reflect ambient conditions, which may result in large daily fluctuations in temperature (McComb *et al.* 2021) and low humidity (Strain *et al.* 2021). Design of nest boxes should therefore incorporate measures to reduce large temperature fluctuations (Ellis *et al.* 2021; Rowland *et al.* 2017). Thermal influence can be reduced by thicker walls, use of light-coloured materials/paint and avoiding the use of metal lids or plates on the roof of the nest box lid.

Modular hollows are a type of nest box produced using injection moulding or 3D printing a plastic box based on scans of natural hollows. Modular hollows may offer better thermal insulation and longevity (UV stabilised) and display a more natural shape and texture compared to typical nest boxes. However, modular hollows are a relatively new technique with limited trials, have higher initial costs to other options and introduce plastics in the natural environment.



Figure 8.2: Greater Glider in a timber nest box (Photo: Sandpiper Ecological Surveys).



Figure 8.3: A front-entry wooden nest box installed for the Princes Highway Upgrade at Termeil Creek in which Sugar Gliders have been recorded (Photo: SMEC).

Carved hollows

Carved hollows are mechanically created by cutting a cavity into a dead or living tree and attaching a primarily wooden face plate or entry modifier to the opening of the cavity (Kenyon and Kenyon 2010; Rueegger 2017; Griffiths *et al.* 2018) to check the entry size is specific to the target species. Carved hollows may also be created in solid logs that are then affixed to trees (BCT 2020). Cavities can be created using chainsaws (Figure 8.4) or large drills (Figure 8.5) that create an entrance and small cavity, which may be enlarged by animals where required. Carving hollows into trees that contain termite-formed ‘mud guts’ is likely to improve the likelihood of animals modifying cavities to suit their needs (Ellis *et al.* 2022).



Figure 8.4: Example of a chainsaw carved hollow showing callous regrowth over the faceplate (Photo: Terry *et al.* 2021).



Figure 8.5: Example of a carved hollow where the cavity is drilled into the tree trunk and a modified collar with perch attached (Photo: Matt Stephens, TfNSW).

Carved hollows are potentially suitable for a wide range of species as entrance and cavity size can be varied to suit the requirements of the target species. Carved hollows may offer a range of improvements over traditional nest boxes including a more suitable microclimate, greater longevity, less maintenance and fewer visual impacts (Rueegger 2017; Griffiths *et al.* 2018).

The selection of host trees and the diameter/depth of carved hollows requires experience and expertise. Therefore, to prevent tree failure, and for safety considerations, carved hollows are only to be created by **suitably skilled personnel under the direct supervision of an AQF Level 5 arborist**. It is recommended that proposals to install carved hollows undertake a pre-installation survey attended by the **ecologist** and **AQF5 arborist**.

Recent improvements in technology resulted in a resurgence in the use of carved hollows, though it is still a relatively novel technique. The design of carved hollows used in much of the research in Australia to date has been based on recommendations by the Victorian Tree Industry Organisation (VTIO 2010). Literature on species utilisation is still growing and the impact of the hollow on recipient tree health is not well documented. Long-term maintenance requirements are also not well known, as studies (Terry *et al.* 2021) have identified carved hollows are vulnerable to a build-up of moisture from water egress and trees can heal hollow entrances over time (Figure 8.4). Carving also exposes the tree to disease and termites (Terry *et al.* 2021). As such, Artificial Hollow Strategies that include monitoring of carved hollows will contribute to the development of this knowledge.

Salvaged hollows

Salvaged hollows are re-used natural hollows from felled trees that are attached to a host tree, often with modifications to close the hollow ends or create/modify an entrance hole (Figure 8.6).

Originating as natural hollows, they are more likely to provide an environment favourable to a target species (particularly if the target species has already been identified using the hollow to be salvaged) compared to more traditional types of artificial hollows.

Where an **Artificial Hollow Strategy** identifies salvaging as a suitable technique for an occupied hollow, installation should aim to replicate the same characteristics (ie height, aspect, tree species) as the original hollow. This method will likely need to be combined with other artificial hollow types to satisfy the requirement of having 70 per cent of artificial hollows installed prior to the commencement of clearing.



Figure 8.6: Modified salvaged hollow installed in a banksia targeting Eastern Pygmy-possum (left) and a hollow showing nesting individuals (right) (Photo: Bob I Jones).

Determining the type and number of artificial hollows required

The following guidance is separated into two distinct fauna groups:

- Non-flying mammals – hollow-dependant species (ie, gliders, possums and phascogales) that are not highly mobile and therefore most likely to be temporarily displaced by clearing of tree hollows. The primary objective of mitigation is to provide short-term supplementary habitat for displaced animals. Research and monitoring have shown artificial hollows are readily used by these species.
- Flying species – given the mobility of flying hollow-dependant species (e.g. birds and microbats), any animals affected by natural hollow loss can theoretically travel to find habitat elsewhere. The objective of mitigation is therefore different to non-flying mammals. Research and monitoring have been generally less successful at detecting use of artificial hollows by these species.

Non-flying mammals

Suitable artificial hollow types and dimensions for a selection of non-flying mammal species (for which artificial hollows have been demonstrated to be effective) are described in Table 8.2. All hollow types (ie, carved hollows, salvaged hollows and nest boxes) are likely to be suitable for these species, with some evidence that arboreal mammals may be more tolerant to heat stress (Goldingay 2019b; Goldingay and Thomas 2021).

Table 8.2: Recommended artificial hollow types and dimensions for a selection of non-flying mammal species

Species	Suitable nest box design	Entrance diameter (mm)	Dimensions (LxWxD) (mm) ¹	Suitable nest box design	Current knowledge and recommendations
Feathertail Glider <i>Acrobates pygmaeus.</i>	'Small glider' box	25	150 x 150 x 300	3	Nest boxes proven effective (Goldingay 2019a). Evidence of use of carved hollows by Feathertail Glider (Rueegger 2017). Carved and salvaged hollows likely suitable for both species (see Figure 8.6).
Eastern Pygmy-possum <i>Cercartetus nanus.</i>	Rear-entry preferred			1-3	
Sugar Glider <i>Petaurus breviceps.</i>	'Medium glider' box	40	150 x 250 x 300	3	Nest boxes and salvaged hollows proven effective (Goldingay 2019a). Recorded use of nest boxes by Brush-tailed Phascogale from several studies is relatively low (Goldingay 2019a, 2020b), likely explainable by several reasons (e.g. large home ranges). Carved hollows proven suitable for Sugar Glider and Brush-tailed Phascogale (see Figure 8.7), with higher uptake than nest boxes (Rueegger 2017; Terry <i>et al.</i> 2021).
Squirrel Glider <i>Petaurus norfolcensis.</i>					
Brush-tailed Phascogale <i>Phascogale tapoatafa.</i>					
Yellow-bellied Glider <i>Petaurus norfolcensis.</i>	'Large glider' box	80 ²	250 x 300 x 300	6 ³	Use of large nest boxes has been recorded (Goldingay 2019a – see Figure 8.2, Honey <i>et al.</i> 2021) though large home ranges for the

Species	Suitable nest box design	Entrance diameter (mm)	Dimensions (LxWxD) (mm) ¹	Suitable nest box design	Current knowledge and recommendations
Greater Glider <i>Petauroides volans</i>		100		8 ³	Yellow-bellied Glider mean that other more-suitable nesting sites may be available in the landscape. Published research describing den characteristics for Greater Glider (Hofman <i>et al.</i> 2022) should be considered. Carved and salvaged hollows potentially suitable.

¹ Dimensions relate to nest box construction. Carved and salvaged hollows would seek similar cavity volumes.

² This species will use 100mm entrance though 80mm is more likely to exclude possums.

³ Lowest height of recorded nest box use by Yellow-bellied Glider is 6m. The lowest height of a Greater Glider den tree is 8m. More work is needed to determine the suitable installation height for large gliders.



Figure 8.7: Images from inside chainsaw hollow cavities of sugar gliders (a-b) and a phascogale in a characteristic nest of stripped stringybark (c) (Photo: Terry *et al.* 2021).

The number of artificial hollows required to mitigate impacts on non-flying mammals can be calculated using **Equation 1**, which is based on three main pieces of information:

- The number of natural tree hollows being removed in each entrance diameter class shown in **Table 8.2**.
- The number of those hollows that are occupied. The average use of hollows in the landscape by non-flying mammals has been shown to be approximately 10 per cent (Lindenmayer *et al.* 2017; Goldingay *et al.* 2018) and a precautionary approach would double this estimate to 20 per cent.
- The number of artificial hollows clusters needed. One cluster of three artificial hollows is required for each occupied hollow removed (Goldingay 2019a). This approach is likely to reduce the potential for competition where larger species that require more than one hollow are present. Placing several artificial hollows of the one design within a cluster is likely to produce a better outcome as it enables individuals to periodically switch artificial hollows to satisfy their needs, such as to assist in parasite control (Goldingay 2019a).

Equation 1: Number of artificial hollows required for non-flying mammals

$$\text{Number of artificial hollow clusters required}^* = 0.2^{**} \times (\text{Number of hollows to be removed})$$

$$\text{Number of artificial hollows required} = (\text{Number of nest box clusters required}) \times 3$$

*Always round this up to a whole number, i.e., for every five hollows impacted, one cluster is required.

**Assumed occupancy rate, i.e., 20 per cent of hollows impacted are occupied.

An example scenario using Equation 1 is provided (Goldingay 2019a), where 50 hollow-bearing trees are being removed, with each tree containing one hollow of suitable size for a species in the ‘small glider’ group (hollow entrance diameter around two to three centimetres). An estimated occupancy rate using 20 per cent assumes that 10 of the 50 hollows are being used by the target species, therefore 10 small glider groups need to be accommodated. Three artificial hollows in a cluster should be provided per glider group. As such, 30 nest boxes should be installed just targeting small gliders.

Flying species

Monitoring and research suggest more work is required to develop effective hollow mitigation for the species listed in Table 8.3 (Goldingay 2019a). While Transport supports new and innovative methods to target these species, any Artificial Hollow Strategy proposing to target these species should:

- Clearly define the objective of mitigation, as the provision of short-term habitat for displaced animals is likely not necessary.
- Mitigate based on specialist ecological advice regarding the ecology (e.g. home range) and breeding habitat requirements of each species.
- Include provisions to monitor the performance of the measures proposed.

Currently, no recommendations are made for rainforest birds, quolls, reptiles or amphibians due to the limited evidence regarding the use of artificial hollows by these fauna groups.

Table 8.3: Flying species and fauna groups that are unlikely to benefit from the provision of short-term habitat and for which further research/trials of artificial hollow suitability is required.

Species/group	Current knowledge and recommendations
Threatened hollow-roosting microbats	<p>Evidence of artificial hollow use by threatened microbat species is limited (Goldingay 2019a, BCT 2020). This suggests the habitat requirements of these species is not well understood (Rueegger <i>et al.</i> 2019) and/or they utilise many non-breeding roost sites within their home range.</p> <p>Replacing potential non-breeding hollows removed with a standard microbat nest box is unlikely to be effective mitigation for most threatened species (Southern Myotis being the main exception). Furthermore, research suggests microbat nest boxes may only be supporting generalist species (e.g. Gould's Wattled Bat) and therefore may be having unintended consequences on microbat community dynamics (Velasco <i>et al.</i> 2023). Therefore, the use of standard microbat boxes to mitigate the loss of small tree hollows assumed to be utilised by threatened microbats is not recommended until further research provides a better understanding of the issue.</p>

	<p>Where impacts to maternity roosts are identified or suspected (e.g. large stag with hollows), any proposal to create artificial breeding habitat should be based on specialist advice and include monitoring. More research is needed to increase understanding of species-specific habitat requirements so that any use of artificial hollows for microbats is targeted and effective. Artificial hollows may still form part of mitigation where microbats are identified in Transport structures (see EMF-BD-GD-0012 <u>TfNSW Microbat Management Guideline</u>).</p>
<p>Threatened cockatoo species</p>	<p>Literature demonstrates some recent success with vertical PVC nest boxes for Carnaby's Cockatoo (Saunders <i>et al.</i> 2020) and Glossy Black Cockatoos (Berris <i>et al.</i> 2018). Research reviews have reported use of salvaged hollows by Red-tailed Black-cockatoo (Goldingay and Stevens 2009) and anecdotal evidence of undescribed nest box use by several threatened species (Macak 2020).</p> <p>Evidence of use of carved hollows by Major Mitchell's Cockatoo (Hurley and Stark 2015).</p> <p>Salvaged hollows are potentially suitable.</p>
<p>Threatened parrot species</p>	<p>Literature demonstrates some recorded success with nest boxes targeting threatened species (Goldingay and Stevens 2009; Stojanovic <i>et al.</i> 2019). Nest boxes are readily used by common parrot species.</p> <p>No published evidence of threatened parrot species using carved hollows, however chainsaw-carved hollows are being implemented and studied for the Superb Parrot. Carved hollows are readily used by common parrot species.</p> <p>Turquoise Parrot recorded nesting and breeding in constructed spout boxes attached to trees and pickets (Strain <i>et al.</i> 2021) and nesting in salvaged nest logs strapped to trees (Quin <i>et al.</i> 2021).</p>
<p>Large forest owls</p>	<p>The suitability of nest boxes for large forest owls is not clear (BCT 2020) and there are other factors in the environment that will influence their presence (e.g. availability of food). There is limited published recorded use of nest boxes by threatened owl species (McNabb and Greenwood 2011, Thomson 2006). Recent efforts targeting Powerful Owl recorded the first known breeding event in a wooden nest box, which took two years from the installation (see https://www.birdsinbackyards.net). Trials are also currently underway of 3D-printed modular hollows for Powerful Owl (University of Melbourne n.d.). Limited recorded use by Eastern Barn Owl and Southern Boobook (Macak 2020).</p> <p>Carved and salvaged hollows are potentially suitable.</p>
<p>Brown Treecreeper (<i>Climacteris picumnus</i>)</p>	<p>Limited recorded use of traditional nest boxes (Lindenmayer <i>et al.</i> 2017). Demonstrated high occupancy and breeding in constructed spout boxes attached to trees and pickets (Strain <i>et al.</i> 2021) and salvaged nest logs strapped to trees (Quin <i>et al.</i> 2021). This demonstrates this species requires a design that contains a vertical hollow with an open top. Carved hollows incorporating this design are potentially suitable.</p>

Installation of artificial hollows

The **Environment Manager** should engage a suitably qualified **Ecologist** to be on-site during the installation of artificial hollows. The **Ecologist** would provide advice on attaching artificial hollows to trees, including the required height and aspect of nest boxes in accordance with the installation requirements in **Artificial Hollow Strategy**.

The timing of artificial hollow installation should consider mitigation objectives. For instance, for alternative shelter to be available for hollow-dependent fauna displaced during clearing, install at least 70 per cent of the artificial hollows required for any particular area of impact before clearing commences. This can be staged where natural hollows are only present within certain areas. The remainder of artificial hollows would be installed once the final number of tree hollows removed has been confirmed, and before completion of the project.

The following should be considered for the installation artificial hollows:

- Consider safety and future monitoring/maintenance when installing artificial hollows. Where future access may be required, consider installing artificial hollows for non-flying mammals no higher than three metres (more evidence needed to determine if three metres is high enough for large gliders). Aluminium identification tags can be placed just above eye level on the host tree.
- Artificial hollows should be installed:
 - As close as possible to the location of the removed hollow-bearing tree.
 - Near potential food resources of the target species.
 - On trees that are most likely to provide other resources for the target species, e.g. stringybark species can provide nesting material and foraging resources (Goldingay *et al.* 2020b).
 - With an orientation that considers the target species' needs. Typically placement on a tree would avoid exposure to hot afternoon sun in summer (particularly when targeting birds). However consider varying the orientation of each artificial hollow in a cluster of three to account for small mammals needing hollows exposed to winter sun.
- Clusters should be spaced at least 200 metres apart (100 – 200 metres is suitable where space is restricted), with individual hollows in each cluster installed 30-50 metres apart on different trees.
- Avoid installing artificial hollows on trees with existing hollows as the presence of other hollow-dependent fauna may act as a deterrent or may compete for the next boxes. Consideration should also be given to the existing density of hollow-bearing trees in vegetation where artificial hollows are proposed to be installed. Vegetation with an existing high density of hollows may not benefit from the addition of artificial hollows.
- During installation of each artificial hollow, record the artificial hollow identification number, artificial hollow type, GPS location, species and diameter at breast height (DBH) of the host tree, artificial hollow height and orientation.

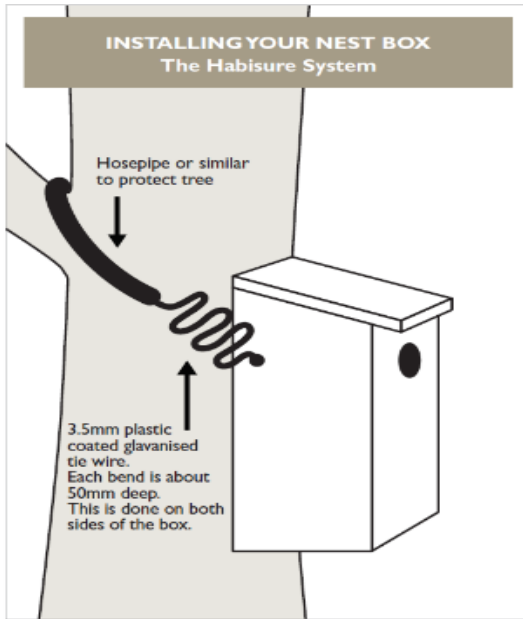

Figure 8.8: The Habisure© system is a common method for attaching nest boxes to trees (left –Photo: Franks and Franks 2006) however can cause tipping when used on small trees (right –Photo: William Terry).

Attachment

The method of attachment is a key factor in determining the lifespan of an artificial hollow (Goldingay 2019a). Importantly, all attachment methods should aim to allow for tree growth, which is a manageable cause of nest boxes falling from trees. The method of attachment must be appropriate for each artificial hollow type and may need to consider location-specific factors (e.g. theft). Small to medium size nest boxes and salvaged hollows can be attached using the Habisure© system, which includes a coiled wire that is designed to expand with tree growth (illustrated in Figure 8.8). However this method can have problems, such as causing artificial hollows to tip on small trees (Figure 8.8) and over time the wire can lose its flexibility. Hanging from a very large (~150mm) galvanised nail inserted into the tree at an angle (see Figure 8.9) allows the hollow to shift slowly along the nail as a tree grows. Both methods allow for tree growth, however in some circumstances a combination of both methods may be required for longevity (see Figure 8.9).

Installation of medium to large, salvaged hollows is likely to require higher costs than other methods. This may include equipment to transport large tree sections (crane, semi-trailer) and a tree-climbing (arborist) crew (**Figure 8.10**). Manoeuvring salvaged hollows requires space and there are potential safety risks if not attached securely. Heavy-duty attachments are required to secure large logs, branches or tree trunks to a host tree. Importantly, the attachment method should allow for tree growth.

For safety, salvaged hollows should not be installed in trees where there is potential for pedestrian traffic below. Further information on installation of salvaged hollows is provided in the Guideline for the Relocation of Large Tree Hollows (Central Coast Council 2016). Salvaged hollow installation should involve an **AQF Level 5 arborist**.



Figure 8.9: A small hardwood nest box hung from a large nail (red arrow) and coiled wire (Photo: Narawan Williams Fauna Field Ecology).



Figure 8.10: Salvaged hollows require machinery and arborists (Photo: Central Coast Council, 2016).

Monitoring and maintenance

The Artificial Hollow Strategy author should consider the requirements of Table 8.4 when developing the monitoring and maintenance requirements of artificial hollows. The purpose of monitoring should be to improve our understanding of mitigation effectiveness. The purpose of maintenance is to ensure artificial hollows are available for use by the target species over the period of time that the objective applies.

It is important that any strategy includes SMART (Specific, Measurable, Achievable, Relevant, and Time-Bound) monitoring objectives. This is so that monitoring gives the answer to the question you seek, and the method gives the data needed. SMART monitoring objectives are needed whether you are targeting a flying species that fits into Table 8.3 or planning to use an untested method.

Table 8.4: Monitoring and maintenance requirements

Fauna group	Monitoring and maintenance
Non-flying mammals (Table 8.2)	<ul style="list-style-type: none"> Regular monitoring for maintenance and species utilisation is not necessary when the primary objective of artificial hollow installation is the provision of short-term shelter sites using proven methods for non-flying mammals displaced by vegetation clearing. Only one inspection between 1-2 years after installation is recommended to check that the hollows remain functional. Identifying species utilisation is typically not needed as a measure of mitigation success. However, the inspection is recommended to align with cooler months (April to

	<p>September) when non-flying mammal species are likely to have dependant young (Goldingay 2019a).</p> <ul style="list-style-type: none"> Where carved hollows are installed, a strategy should consider an inspection at around 3 years after installation to examine the hollow condition, i.e., check for callous growth over entrance and/or moisture build-up (Terry <i>et al.</i> 2021).
<p>Flying species (Table 8.3)</p>	<ul style="list-style-type: none"> Any strategy targeting a species in Table 8.3 should include details of monitoring for at least three years. Monitoring timeframes should enable the mitigation objectives to be assessed. Monitoring would identify any maintenance required during this period, though the strategy should specify the period for which maintenance is required.

The following should also be considered for monitoring and maintenance:

- If novel methods are being trialled, then monitoring can contribute to understanding the uptake and effectiveness of the method. In these situations, monitoring requirements should be detailed in the Artificial Hollow Strategy.
- Where monitoring of hollows is aimed at detecting species use, particularly where new methods are being trialled or artificial hollow use by the target species is not well understood, the use of remote cameras installed pointing at the hollow entrance should be considered as a monitoring method (Figure 8.11). Remote cameras have been found to detect significantly more species than physical observation (Honey *et al.* 2021) as they can sample much longer periods of time.
- Specific maintenance activities for the removal of European Honeybees from artificial hollows is not required. Bees will eventually abandon their hives and the hollow will again become available to be used by native species (Goldingay *et al.* 2020a).



Figure 8.11: Example of remote camera installed via a bracket to monitor a carved hollow (Photo: William Terry).

Supporting documents

Environmental assessment and associated supporting documents (e.g. ecological report, conditions of approval).

Environmental management plans and associated sub-plans and procedures for the works.

Department of Planning and Environment (2003) Scientific Committee Final Determination: Removal of dead wood and dead trees - key threatening process listing.

Department of Planning and Environment (2007) Scientific Committee Final Determination: Loss of hollow-bearing trees - key threatening process listing.

Related Transport for NSW documents and other resources

Transport for NSW Microbat Management Guidelines: A guide for undertaking works in culverts, bridges and other structures (Access via the TfNSW Environment and Sustainability Source SharePoint site or the TfNSW Biodiversity webpage).

Transport for NSW QA Specification for roads G40 Clearing and Grubbing (Access via the TfNSW intranet 'CPS documents directory' page).

Transport for NSW QA Specification G36 Environment Protection for road (Access via the TfNSW intranet 'CPS documents directory' page).

Transport for NSW QA Specification R178 Vegetation (Access from the intranet 'Roadworks specifications - TAD' page)

Transport for NSW Standard requirements (Works Contract) DMS-FT-425 (PDF, 745.67 KB) for rail (Access via <https://www.transport.nsw.gov.au/projects/project-delivery-requirements>)

Transport for NSW Transport Biodiversity Policy (Access via the TfNSW Environment and Sustainability Source SharePoint site or the TfNSW Biodiversity webpage).

Transport for NSW Tree and Hollow Replacement Guideline (Access via the TfNSW Environment and Sustainability Source SharePoint site)

External access to relevant Transport for NSW documentation can be requested by emailing environmentandsustainability@transport.nsw.gov.au.

Overview – Guide 8: Artificial hollows

Objective

The objective of this Guide is to provide a resource for designing all components of mitigation to address the impact of natural hollow loss from TfNSW projects

Application of this Guide

This Guide is applicable to any project where hollow-bearing trees are to be removed and artificial hollows are required to mitigate habitat loss. For projects with hollow replacement requirements under the [Transport Biodiversity Policy 2022](#), this Guide should be read in conjunction with the EMF-BD-GD-0129 TfNSW [Tree and Hollow Replacement Guidelines](#).

Figure 8.1 describes the decision workflow and key steps for mitigation of hollow loss. Specialist input is required for various tasks during the process.

Management requirements

- Projects requiring artificial hollows should engage a suitably qualified **Ecologist** to develop an **Artificial Hollow Strategy**.
- The information required to develop an **Artificial Hollow Strategy** can be collected during the environmental impact assessment. However targeted surveys may also be required to quantify and categorise the hollows removed and identify locations suitable for installation.
- Three main types of artificial hollows are available: nest boxes, carved hollows and salvaged natural hollows. Each type has advantages and disadvantages; therefore the proposed artificial hollow design needs to be appropriate for the target species and suitable for the installation location.
- Non-flying mammals readily use artificial hollows. The entrance size of artificial hollows should be no bigger than that required for the target species.
- The number of artificial hollows provided for non-flying mammals can be calculated using Equation 1 from this Guide. Every occupied natural hollow (assume 20 per cent of suitable hollows are occupied) requires a cluster of three artificial hollows. Clusters of three artificial hollows should be spaced at least 200 metres apart, with individual hollows in each cluster installed 30-50 metres apart on different trees.
- Monitoring and research suggest more work is required to develop effective hollow mitigation for flying species. Any intention to target flying species should clearly define the objective of mitigation. The **Artificial Hollow Strategy** should contain specialist ecological advice and the performance of mitigation should be monitored.
- Install at least 70 per cent of artificial hollows before the start of any clearing to provide alternative shelter for hollow-dependent fauna displaced during clearing. The remainder of artificial hollows would be installed once the final number of tree hollows removed has been confirmed, and before completion of the project.
- The method of attachment should allow for tree growth, be appropriate for each artificial hollow type and may need to consider location-specific factors.

- Regular monitoring for maintenance and species utilisation for non-flying mammals is not necessary. Only one inspection between 1-2 years after installation is required to check that the hollows remain functional. Carved hollows should be inspected 3 years after installation to examine the hollow condition.
- Any strategy targeting a flying species should include details of monitoring for at least three years.

Guide 9: Fauna handling

Background

Handling of fauna may be necessary when they are encountered on a project and need to be relocated or, if injured, taken to a **vet** or **licensed handler**. The careful handling of fauna is essential to minimise stress or further injury on the animal, to prevent the spread of diseases and to avoid injury to fauna handlers.

Fauna should only be handled when absolutely necessary. It is preferable to avoid fauna handling unless the life of the animal is at risk. Fauna handling should be undertaken either by an **Ecologist** or **licensed handler** skilled in handling the type of fauna encountered.

Objective

The objective of this Guide is to minimise impacts on fauna as a result of being handled by humans and prevent injury to people handling fauna.

Application of this Guide

This Guide is applicable whenever it is necessary to handle fauna.



Figure 9.1: Eastern Crevice Skink (*Egernia mcphreei*) being handled by an **Ecologist** with gloves during staged clearing for the Woolgoolga to Halfway Creek Pacific Highway Upgrade (Photo: Sandpiper Ecological Surveys).



Figure 9.2: Koala (*Phascolarctos cinereus*) found during construction of an overtaking lane project on Newell Highway near Moree September 2017 (Photo: Graham Skaines, TfNSW).

Specialist input requirements

Use an **Ecologist** or **licensed handler** with specific animal handling experience to carry out any animal handling. Veterinarian advice should be sought when dealing with injured animals.

Any person handling fauna must hold the appropriate licence/s granted under the NSW *Biodiversity Conservation Act 2016* (see **Licences**).

Management requirements

The **Environment Manager** should develop an **unexpected animal onsite protocol** for the site where it is near bushland and check it is included in project inductions, toolbox talks and pre-start meetings. The protocol should provide that the:

- Site manager and environment staff are notified when unexpected animals are found.
- Potentially harmful works cease in the vicinity of the animal.
- Personnel leave the area where the animal is a potentially dangerous animal.
- Fauna should be allowed to leave an area without intervention and handling of the animal is to be avoided wherever possible.
- Fauna must only be handled by people who are appropriately licensed under the *Biodiversity Conservation Act 2016* unless this cannot be practically avoided, in which case appropriate safety considerations need to be applied. Under no circumstances, however, are unlicensed personnel to handle bats.
- Veterinarian advice should be sought for any injured animals as required.
- Contact details of an **Ecologist** and/or licensed handlers and/or available vet services are available to the site manager, displayed in the site office and included in the Construction Environmental Management Plan (CEMP).

The **Environment Manager** should support the best practice methods outlined below so that they are communicated to the site team in circumstances where the handling of fauna is completely unavoidable.

Before works start the **Environment Manager** should check that a licensed handler has been contacted to confirm availability to be involved in fauna rescue. The **Environment Manager** should also contact local veterinarians to check that they are will and available to receive injured fauna.



Figure 9.3: A non-venomous Carpet Python (*Morelia spilota*) being removed by a licensed Ecologist with skills and experience in snake handling. This was during staged habitat removal at the Woolgoolga to Ballina project in Northern Region (Photo: Anthony Arena, TfNSW).

The **Environment Manager** should advise personnel to not feed any wildlife that may be encountered on construction sites (especially birds and lizards). The **Environment Manager** should include this in project inductions and erect relevant signs informing personnel not to feed the wildlife around the work site.

In addition to the above, the following sections provide further guidance for handling certain fauna types.

Injured fauna

Contact the nominated licensed handler if an animal is injured. If possible, keep the injured animal in a box in a quiet, warm, dark place until transferred to the care of the licensed handler. If the animal is dangerous section off the area and wait for a licensed handler to arrive. Arrange for veterinarian advice and services as required in consultation with the licensed handler.

Snakes

- Avoid handling snakes. Snakes should be left alone and allowed to vacate the area of their own accord.
- If a snake must be handled to remove the risk of harm to the snake or people then handling should only be done by an **Ecologist, licensed handler, or licensed reptile handler** with skills and experience in snake handling. Snake handling requires a specific licence granted under the BC Act (see Licences).
- Never deliberately kill a snake as all snakes are protected under the *Biodiversity Conservation Act 2016* (NSW).

Amphibians

Follow the Hygiene Guidelines for wildlife (DPIE 2020) for all frog handling. Key points include:

- Wear disposable gloves when handling frogs and change gloves for each individual frog.
- Place only one frog in each plastic bag.
- Do not re-use plastic bags.
- Disinfect any handling equipment and boots when moving between waterbodies.
- Wash hands thoroughly with disinfectant/change gloves after handling frogs from one waterbody.
- Frogs or tadpoles/spawn should not be moved between catchments.

Guide 7: Pathogen management provides further information on managing diseases in frogs.



Figure 9.4: An endangered Giant Barred Frog (*Mixophyes iteratus*) being relocated from the Sapphire to Woolgoolga project corridor in a plastic bag (Photo: Laurene O'Brien, TfNSW).

Fish

- Handle fish with dip nets with knotless or rubber netting and/or with wet hands or wet gloves.
- Avoid contact with gills and eyes.
- Keep fish in water whenever possible. If fish need to be transferred between water bodies they should not be left out of the water for more than a few seconds.
- Fill containers used for transferring fish between sites with water from the source, except where chytrid is identified or suspected to be present. Keep water oxygenated and at the same temperature as the source.
- Fish should not be moved between catchments.



Figure 9.5: An aerated fish transport container. (Photo: Mathew Birch, Aquatic Science and Management)

Mammals

- To protect against bites and scratches, gloves should be worn when handling mammals.
- Transfer small mammals to a small cloth bag after capture and before release. Larger mammals may require a large pillow case or hessian bag.
- To reduce risk of contracting Australian Bat Lyssavirus (ABLV), which is a form of rabies, an **Ecologist** or **licensed handler** should be vaccinated prior to handling bats.
- Contact or exposure to bat faeces, urine or blood do not pose a risk of exposure to ABLV, or does working near bat roosting areas, as long as microbats are not handled (NSW Health 2021).

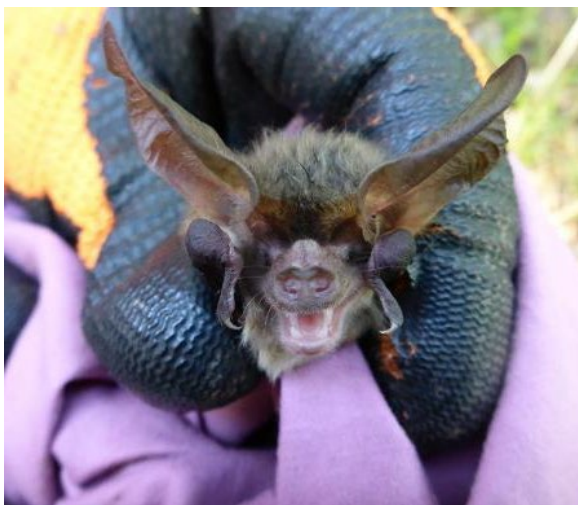

Figure 9.6: Microbats such as the Gould's Long-eared Bat (*Nyctophilus gouldi*) should only be handled by a **licensed and experienced handler** and/or **Ecologist** who has been vaccinated against the Australian Bat Lyssavirus (Photo: Geolink).



Figure 9.7: A Yellow-footed Antechinus (*Antechinus flavipes*) removed from a hollow by an **Ecologist** during staged habitat clearing for the Woolgoolga to Halfway Creek Pacific Highway Upgrade (Photo: Sandpiper Ecological Surveys).

Fauna release

- Release fauna into pre-determined habitat identified for fauna release. This habitat would have been identified by an **Ecologist** and marked on maps for the project during the pre-clearing process. See [Guide 1: Pre-clearing process](#). Release fauna into similar habitats, as near as possible to their capture location.
- Release nocturnal fauna at or after dusk. Nocturnal fauna can be released during the day if there is suitable refuge for them, (e.g. artificial or natural hollow).
- Select trees with the appropriate features for the species being released, e.g. trees with rough or peeling bark and refuge/hollows for bats and gliders (Figure 9.8).



Figure 9.8: A Sugar Glider (*Petaurus breviceps*) being released on a tree with rough bark close to where it was captured (Photo: Amy Evans, TfNSW).

Monitoring

The Environment Manager should record details of fauna captured and relocated. Include the following information:

- Species.
- Location and time captured.
- Location and time released.
- Behaviour and condition upon release.
- Details of any injury or deaths that occurred.
- Contact details and location of the **licensed handler** or **vet** if the animal was transferred into their care.

The **Environment Manager** should promptly report any injury to or death of a threatened species to the **Authorised Representative**.

Management of Cane Toads

To carry out Biosecurity Duty of care it is recommended that Cane Toads (*Rhinella marina*) inadvertently introduced from outside areas (e.g. through sugar cane mulch) are caught immediately using protective clothing/gloves/eyewear and held in containers that are closed and adequately ventilated. Protection is required because when stressed, Cane Toads can ooze and sometimes squirt poison from glands.

Cane Toads are considered to have established populations in north-east NSW from Yamba north to the QLD border and west to near Casino. (see [DPI website](#) for mapping and more information). Cane Toads and their tadpoles can be identified using Figure 9.9 and Figure 9.10.

Report such a finding to the **Environment Manager** and discuss most appropriate method of euthanasia. Animals can only be euthanised once they are positively identified by an **Ecologist** as non-native. Biosecurity findings should be reported to DPI ([Report a biosecurity concern](#)).



Figure 9.9: Key identifying features of Cane Toads (Photo: DPI).



Figure 9.10: Cane Toad tadpoles can be distinguished from native frog tadpoles by being big and black (Photo: Anstis 2017).

Supporting documents

Department of Climate Change, Energy, Environment and Water [Chytrid amphibian fungus - Chytridiomycosis.](#)

NSW Health. (2021). [Rabies and Australian bat lyssavirus infection fact sheet.](#)

Department of Planning, Industry and Environment (2020) [Hygiene guidelines for wildlife: Protocols to protect priority biodiversity areas in NSW from *Phytophthora cinnamomi*, myrtle rust, amphibian chytrid fungus and invasive plants.](#)

[Hygiene protocols for the control of diseases in Australian frogs - PDF version \(dceew.gov.au\)](#)

NSW Health (Updated 26 July 2019) [Rabies and bat lyssavirus infection: Infectious disease fact sheet](#) NSW Health.

NSW Health (Updated 31 May 2021) [Leptospirosis: Infectious disease fact sheet](#) NSW Health.

Related Transport for NSW documents and resources

Sydney Trains [EMS-06-WI-0178 Fauna Impact Mitigation When Clearing Vegetation.pdf](#)

Transport for NSW [Microbat Management Guidelines: A guide for undertaking works in culverts, bridges and other structures](#) (Access via the TfNSW Environment and Sustainability Source SharePoint site or the [TfNSW Biodiversity webpage](#)).

External access to relevant Transport for NSW documentation can be requested by emailing environmentandsustainability@transport.nsw.gov.au.

Overview-Guide 9: Fauna handling

Objective

The objective of this Guide is to minimise impacts on fauna as a result of being handled by humans and prevent injury to people handling fauna.

Application of this Guide

This Guide is applicable whenever it is necessary to handle fauna.

Management requirements

- Allow fauna to leave an area without intervention as much as possible.
- Use an **Ecologist** or **licensed handler** with specific animal handling experience to carry out any fauna handling and check they are licensed.
- Contact **vet** and/or **licensed handler** before works start to check they are willing and available to be involved in fauna rescue and assist with injured animals.
- Seek the advice and services of a vet when dealing with injured animals as required.
- The contact details of **Ecologist, licensed handler** and **vet** should be provided to the site manager, displayed in the site office and included in the CEMP or other relevant management plans for the project.
- Develop an **unexpected animal onsite protocol** as part of your CEMP to ensure that the **Environment Manager** and site supervisor are notified when unexpected animals are found, that potentially harmful works cease in the vicinity of an animal and, in the case of a potentially dangerous animal, all personnel leave the area. The protocol should also cover the steps required to manage any injured animal.
- Do not feed wildlife and check that staff are made aware of this requirement.

Follow the best practice methods outlined below in circumstances where the handling of fauna is completely unavoidable:

- Contact the nominated **licensed handler** or vet if an animal is injured. Keep the injured animal in a box in a quiet, warm, dark place until transferred. If an injured animal is dangerous, carefully place a box over the top of it if possible, or section off the area and wait for an experienced and licensed fauna **Ecologist** or **licensed handler** to arrive.
- Never deliberately kill a snake as all snakes are protected under the *Biodiversity Conservation Act 2016* (NSW).
- If a snake must be handled to remove the risk of harm to the snake or people then handling should only be done by an **Ecologist, licensed reptile handler** or **appropriately licensed handler** with skills and experience in snake handling.
- Follow the Hygiene guidelines for wildlife for (DPIE 2020) for all frog handling.
- Fish should only be handled by an **Ecologist**.
- Wear gloves when handling mammals, including bats, to protect against bites and scratches.

- To reduce risk of contracting Australian Bat Lyssavirus (ABL), which is a form of rabies, the **Ecologist** and/or **licensed handler** must be vaccinated prior to handling bats.
- Release fauna into pre-determined habitat identified for fauna release.
- Release fauna into similar habitats, as near as possible to their capture location. Release nocturnal fauna at dusk.
- Keep records of fauna captured and relocated.
- Report any injury to or death of a threatened species to TfNSW environmental staff.

Guide 10: Aquatic habitats and riparian zones

Background

Aquatic habitats and adjacent riparian zones contain significant biodiversity habitats which range from coastal wetlands and estuaries, rivers and creeks and upland swamps, and wetlands. Special care is required to minimise damage, maintain fauna values including connectivity and to restore and rehabilitate following construction.

Aquatic habitats include all areas of land submerged by water, permanently or intermittently, and include both artificial and natural bodies of water. It includes wetlands, rivers, creeks, lakes, dry riverbeds and estuaries.

The riparian zone is land alongside these aquatic habitats. The distance the riparian zone extends from an aquatic habitat varies depending on factors such as the nature of the waterway and the local geology, landform and vegetation.

The [Guidelines for riparian corridors on waterfront land Fact Sheet](#) provides guidance to define the width of the riparian zone given the type of aquatic habitat present.

Vegetated riparian zones perform a range of important environmental functions including providing bed and bank stability and reducing bank and channel erosion, protecting water quality by trapping sediment, nutrients and other contaminants, providing habitat and connectivity for native flora and fauna, and attenuating flood waters.

The protection, restoration or rehabilitation of vegetated riparian zones is important for maintaining or improving the shape, stability (or geometric form) and ecological functions of the aquatic habitat.



Figure 10.1: Even disturbed aquatic habitat and riparian zones can provide important resources for flora and fauna. This waterway on the Woolgoolga to Ballina Pacific Highway Upgrade Project is being inspected by a DPI Fisheries officer (Photo: Anthony Arena, TfNSW).

Aquatic habitats and riparian zones providing habitats and resources for a large number of terrestrial and aquatic flora and fauna. Even heavily disturbed and weed-infested riparian zones can play an important ecological role. Some aquatic habitats are identified as Key Fish Habitat (KFH), which are important to the sustainability of the recreational and commercial fishing industries, the maintenance of fish populations, and the survival and recovery of threatened aquatic species.

Construction within aquatic habitats and riparian zones can disturb aquatic habitats, alter flow or obstruct fish passage and can also impact downstream aquatic biodiversity. Damage can be caused by the movement of machinery, vehicles and personnel and through unsuitable clearing procedures during construction.

The 'Degradation of native riparian vegetation', 'Alteration to the natural flow regimes of rivers and streams and their floodplains and wetlands', and the 'Removal of large woody debris (snags) from rivers and streams' are listed as Key Threatening Processes under the *Fisheries Management Act 1994* (NSW) (FM Act).

Construction within aquatic habitats and/or riparian zones may require consultation with the **Regional Fisheries Conservation Managers** of the NSW Department of Primary Industries (DPI) (Fisheries).

Some activities may require permits including temporary or permanent obstruction of fish passage, disturbance seabed including dredging, use of explosives in a waterway or harm to marine vegetation including saltmarsh, mangroves and seagrass. A list of development activities that require a permit can be found on the [DPI website](#).

Objective

The objective of this Guide is to provide management advice for limiting impacts on aquatic flora and fauna and their habitats, and to maintain the movement of fish up and downstream at all times during works in a waterway.

Application of this Guide

This Guide is applicable to all TfNSW construction sites where works are in an aquatic habitat or within the riparian zone.

Specialist input requirements

Consult with the regional Fisheries Conservation Manager. Contact details for regional Fisheries Conservation Managers in each catchment area can be found on the [DPI website](#)

Management requirements

Aquatic habitats and riparian zones are sensitive environmental areas and any activities in these areas should be avoided as much as practicable. If activities are required in these areas, existing guidelines that detail design and management measures are:

- Department of Primary Industries (Fisheries) (2013) [Policy and Guidelines for Fish Habitat Conservation and Management \(update 2013\)](#).
- Department of Environment and Climate Change (DECC) (2008) [Managing urban stormwater: Soils and construction, Volume 2D: Main Road Construction](#), Sydney ('Blue Book').
- Landcom (2004) [Managing urban stormwater Vol 1](#) ('Blue Book')

- Fairfull, S and Witheridge, G (2003) Why do fish need to cross the Road? Fish passage requirements for waterway crossings, NSW Fisheries, Cronulla.

The environmental assessment may have identified special requirements that constrain the timing of work such as periods of threatened fish migrations, or periods where flooding is identified as a risk.

The **Environment Manager** should check that the sensitivity of aquatic habitats and riparian zones and the measures in place to protect them are regularly communicated to all staff (e.g. during inductions and toolbox talks).

Establish exclusion zones within aquatic habitats and riparian zones

The **Environment Manager** should check that aquatic habitats and riparian zones where works are not required are protected by exclusion zones. The following guidance should be followed when establishing exclusion zones within aquatic habitats and riparian zones:

- Mark out and manage exclusion zones according to Guide 2: Exclusion zones.
- Exclusion fencing should not be installed in the waterway, within three metres of the top of the bank or in sensitive areas (e.g. saltmarsh or mangroves). Exclusion fencing should be used outside these sensitive areas.
- Identify the construction footprint within the waterway on a map and include in relevant plans such as a Construction Environmental Management Plan (CEMP). The location of aquatic habitat features within or adjacent to the footprint should be clearly identified on the map (e.g. snags, aquatic vegetation, seagrass beds and gravel beds).



Figure 10.2: Working in riparian zones requires measures to protect the waterway, including geofabric to control erosion/sedimentation and exclusion fencing (Photo: TfNSW).

Accessing the waterway / dredging

The **Environment Manager** should check that:

- Prior to use at the site and / or entry into the waterway, machinery is to be appropriately cleaned, degreased and serviced.
- Access to the waterway minimises the removal of riparian vegetation.
- Access to the waterway is restricted to the minimum amount of bank length required for the construction activity.
- Any dredging activities required will be minimised as far as practicable and a Soil and Water Management Plan (SWMP) is in place.
- Appropriate erosion and sediment controls are in place prior to commencing activities.
- DPI Fisheries is notified prior to any dredging activities and all necessary permits obtained.
- Vehicles and machinery are kept away from the banks of a waterway where possible.
- Refuelling of vehicles and plant, and chemical storage and decanting does not take place within 50 metres of aquatic habitats or riparian zones. Where this is not possible these activities must occur within a double-bunded area.
- Boats or other water craft are used in a manner so as to avoid boat wash that could cause erosion of the banks and propeller damage to seagrass beds.

Clearing of riparian and aquatic vegetation

See Guide 4: Clearing of vegetation and removal of bushrock and Guide 5: Re-use of woody debris and bushrock when vegetation clearing is required. In addition, the **Environment Manager** should check that the following is considered:

- Clearing is avoided within the riparian zone during periods when flooding is likely to occur.
- Works are undertaken in accordance with any permit issued by DPI under the FM Act for the harm or removal of saltmarsh, mangroves and seagrass.
- Appropriate erosion and sediment controls are in place prior to commencing activities.
- Clearing employs controlled methods that do not allow vegetation/trees to fall into or otherwise enter the waterway.
- Clearing is only undertaken immediately prior to works in that specific location.
- Retaining the roots and stumps of trees on the bank of a waterway in order to maintain bank stability. Cut trees off



Figure 10.3: Snag timber from the Hume Highway Duplication project was placed in the Murray River and now provides habitat for threatened native fish species such as Murray Cod (*Maccullochella peelii peelii*) and Trout Cod (*Maccullochella macquariensis*) (Photo: J Fredrickson, DPI).

between 300 and 600 millimetres above the ground level.

- Consulting with **DPI Fisheries** and/or **Local Land Services (LLS)** before clearing to identify any trees proposed to be removed that could potentially be used for re-snagging of a waterway. See [Guide 5: Re-use of woody debris and bushrock](#).
- Managing Willows (*Salix* species) and other weed species in accordance with [Guide 6: Weed management](#).

Removal/relocation of snags

Snags are large woody debris, consisting of branches, trunks and whole trees that fall into rivers and streams. Such objects may be in the range of 1-30 metres in size and may be full trees, trunks, branches, tree heads or root masses. Snags form essential habitat for aquatic and terrestrial flora and fauna (Fisheries Scientific Committee n.d).

Snags may need to be removed and/or relocated before undertaking works. Only the minimum number of snags should be disturbed. The **Environment Manager** should apply the hierarchy below (low to high impact) when snags need to be disturbed:

- **Lopping** (lowest impact) – protruding limbs are cut and allowed to sink to the river bed.
- **Realignment** – the snag is rotated from its existing position.
- **Relocation** (highest impact) – the snag is physically moved from one location in the waterway to another location. Relocation of snags should be undertaken so as to cause the least disturbance to the bed or nearby sensitive aquatic habitat.
- **Removal** – the snag is completely pulled from the water.

The **Environment Manager** should check that **DPI Fisheries** are consulted where snags are proposed to be lopped, realigned, relocated and/or removed.



Figure 10.4: An Engineered Log Jam (ELJ) constructed using 'pin logs' and 'rootball logs' salvaged during clearing works creates aquatic habitat and protects from bank erosion achieving good river health outcomes (Photo: LLS).

Dewatering aquatic habitat

Dewatering of aquatic habitat may be required, for example infilling of farm dams or construction of cofferdams. The process of dewatering should include measures to protect aquatic fauna, including capture and release. Handling of aquatic fauna should be undertaken in accordance with [Guide 9: Fauna handling](#).

Relocation sites for turtles should consider potential for inadvertent vehicle strike or dispersing individuals.



Figure 10.5: A Macquarie River Turtle (*Emydura macquarii macquarii*) salvaged and relocated during dewatering for Coffs Harbour Bypass (Photo: Mathew Birch, Aquatic Science and Management).

Site rehabilitation

The **Environment Manager** should check that the following is considered during site rehabilitation in consultation with **DPI Fisheries** and **LLS** where appropriate:

- Stabilising the banks of the waterway through revegetation (Figure 10.6) and/or armouring (Figure 10.7) according to available landscape plans.
- Banks are protected from stock and/or human access (Figure 10.7).
- Appropriate fencing is used during rehabilitation and maintenance (Figure 10.7).



Figure 10.6: Planting wetland species and placement of rock within the Woronora River to reestablish aquatic habitats following completion of the Heathcote Road Bridge upgrade (Photo: Julie Ravallion, TfNSW).

- Temporary stabilisation techniques are used while long-term measures such as the revegetation are establishing (techniques are described in the Blue Book Managing urban stormwater Vol 1).
- Removing temporary works, flow diversion barriers and sediment control barriers within aquatic habitats as soon as practicable and in a manner that does not promote future channel erosion.
- Where creek bed diversions are required for bridge construction, consider revegetation of the creek bed prior to bridge installation to assist plant establishment (i.e. prior to shading and other effects).



Figure 10.7: Before (above) and after (below) bank erosion management on the Hunter River at Millers Forest 2018-2020. Log walls were constructed from large woody debris salvaged during vegetation clearing (Photos: LLS).

Supporting documents

Environmental assessment and associated supporting documents (e.g. ecological report, conditions of approval).

Environmental management plans and associated sub-plans and procedures for the works.

Department of Environment and Climate Change (DECC)(2008) 'Blue Book' Managing urban stormwater: Soils and construction, Volume 2D: Main Road Construction.

Department of Planning and Environment Controlled activities – Guidelines for riparian corridors on waterfront land

Department of Primary Industries (Fisheries) (2013) Policy and Guidelines for Fish Habitat Conservation and Management (Update 2013).

Department of Primary Industries Primefact 30: Aquatic weed management in waterways and dams.

Fairfull, S and Witheridge, G (2003) Why do Fish Need to Cross the Road? Fish Passage Requirements for Waterway Crossings. NSW Fisheries, Cronulla.

Landcom (2004) 'Blue Book'Managing urban stormwater Vol 1.

Related Transport for NSW related documents and resources

Transport for NSW QA Specification G36 Environment Protection for road (Access via the TfNSW intranet 'CPS documents directory' page).

Transport for NSW Standard requirements (Works Contract) DMS-FT-425 (PDF, 745.67 KB) for rail (Access via <https://www.transport.nsw.gov.au/projects/project-delivery-requirements>)

External access to relevant Transport for NSW documentation can be requested by emailing environmentandsustainability@transport.nsw.gov.au.

Overview – Guide 10: Aquatic habitats and riparian zones

Objective

The objective of this Guide is to provide management advice for limiting impacts on aquatic flora and fauna and their habitats, and to maintain the movement of fish up and downstream at all times during works in a waterway.

Application of this Guide

This Guide is applicable to construction activities in aquatic habitats and within the riparian zone.

Aquatic habitats include all areas of land submerged by water, permanently or intermittently, and include both artificial and natural bodies of water. It includes wetlands, rivers, creeks, lakes, dry riverbeds and estuaries.

The riparian zone is land alongside these aquatic habitats. The distance the riparian zone extends from an aquatic habitat varies depending on factors such as the nature of the waterway and the local geology, landform and vegetation.

This [Fact Sheet](#) provides guidance to define the width of the riparian zone given the type of aquatic habitat present.

Management requirements

- Avoid activities in aquatic habitats and riparian zones as much as practicable.
- The sensitivity of aquatic habitats and riparian zones and the measures in place to protect them should be regularly communicated to all staff (e.g. during inductions and toolbox talks).
- Protect aquatic habitats and riparian zones where works are not required with exclusion zones. Exclusion fencing should be used outside sensitive areas (e.g. saltmarsh or mangroves).
- The location of aquatic habitat features within or adjacent to the footprint should be clearly identified on environmental management plans.
- Access the waterway so that riparian vegetation removal is minimised and restricted to the minimum amount of bank length required for the construction activity.
- Refuelling of vehicles and plant, and chemical storage and decanting should not take place within 50 metres of aquatic habitats.
- Use boats or other watercraft in a manner to avoid boat wash that could cause erosion of the banks and propeller damage to seagrass beds.
- Avoid clearing within the riparian zone during periods when flooding is likely to occur.

- A permit is required under the *Fisheries Management Act 1994 (NSW)* (FM Act) for the harm or removal of saltmarsh, mangroves and seagrass or any other activity involving disturbance to the seabed.
- Ensure clearing does not allow the vegetation/trees to fall into the waterway.
- Retain the roots of trees on the bank of a waterway in order to maintain bank stability.
- Consult with Department of Primary Industries (DPI) Fisheries before clearing to identify any trees proposed to be removed that could potentially be used for re-snagging of a waterway.
- Only the minimum number of snags should be disturbed. DPI Fisheries should be consulted before works commence where snags require lopping, realignment, relocation and/or removal.
- During rehabilitation, stabilise the banks of the waterway through revegetation and/or armouring according to available landscape plans.
- Protect banks from stock and/or human access using appropriate fencing during the rehabilitation and maintenance period of the work site.
- Remove all temporary works, flow diversion barriers and sediment control barriers within aquatic habitats as soon as practicable and in a manner that does not promote future channel erosion.
- Keep vehicles and machinery away from the banks of a waterway where possible.

References

Ainsworth, N and Bowcher, A (2005) Guidelines for Herbicide Use near Water, Cooperative Research Centres (CRC) for Australian Weed Management, South Australia.

Anstis, M. (2017) *Tadpoles and frogs of Australia*. New Holland Publishers Pty Limited.

Australian Standard 4373 (2007) Pruning of Amenity Trees.

Australian Standard 4970 (2009) Protection of Trees on Development Sites.

Berris, K.K., Barth, M., Mooney, T., Paton, D., Kinloch, M., Copley, P., Maguire, A., Crowley, G. and Garnett, S.T., (2018). *From the brink of extinction: Successful recovery of the glossy black-cockatoo on Kangaroo Island*. Recovering Australian Threatened Species: a book of hope, 1, p.75.

Biodiversity Conservation Trust (BCT), (2020). *Guideline for Artificial Hollows*. For private land conservation agreements.

Central Coast Council, (2016). *Guideline for the Relocation of Large Tree Hollows*. Report prepared by Travers Bushfire and Ecology for Central Coast Council.

Department of Climate Change Energy Environment and Water (2018) Threat abatement plan for disease in natural ecosystems caused by *Phytophthora cinnamomi*.

Department of Climate Change Energy Environment and Water (2018) Infection of amphibians with chytrid fungus resulting in chytridiomycosis (2016).

Department of Environment and Climate Change (DECC)(2008) 'Blue Book' Managing urban stormwater: Soils and construction, Volume 2D: Main Road Construction.

Department of Planning and Environment (1999) Scientific Committee Final Determination: Key threatening process – bushrock removal.

Department of Planning, Industry and Environment (2020) Hygiene guidelines for wildlife: Protocols to protect priority biodiversity areas in NSW from *Phytophthora cinnamomi*, myrtle rust, amphibian chytrid fungus and invasive plants.

Department of Primary Industries NSW Weed Control Handbook Department of Primary Industries.

Department of Primary Industries *Policy and Guidelines for Fish Habitat Conservation and Management (Update 2013)* (Eds. S Fairfull and SMcGirr) DPI, Wollongbar.

Department of Primary Industries Primefact 1331 Jun 2017 Panama Disease.

Department of Primary Industries Primefact 1417 July 2015 Myrtle rust.

Department of Primary Industries Primefact 30 Nov 2008 Aquatic weed management in waterways and dams.

Ellis, M.V., Rhind, S. and Calver, M., (2021). *Designing better nestboxes: double-walled and pale proves coolest under the sun*. Pacific Conservation Biology.

Fairfull, S and Witheridge, G (2003) Why do Fish Need to Cross the Road? Fish Passage Requirements for Waterway Crossings. NSW Fisheries, Cronulla.

Fisheries Scientific Committee (n.d.) Recommendation to list 'Removal of Large Woody Debris as a Key Threatening Process under Part 7A, Division 2 of the *Fisheries Management Act 1994*.

Florabank website (2021) Florabank Guidelines.

- Franks, A. and Franks, S., (2006). *Nest Boxes for Wildlife: A Practical Guide*, Blooming Books, Melbourne.
- Gibbons P. and Lindenmayer DB., (1997) *Conserving hollow-dependent fauna in timber production forests. Environmental heritage monograph series no. 3*. New South Wales NPWS, Sydney.
- Gibbons P. and Lindenmayer DB., (2002) *Tree hollows and wildlife conservation in Australia*. CSIRO Publishing, Melbourne.
- Goldingay, R.L., Quin, D.G., Talamo, O. and Mentiplay-Smith, J., (2020b). *Nest box revealed habitat preferences of arboreal mammals in box-ironbark forest*. *Ecological Management & Restoration*, 21(2), pp.131-142.
- Goldingay, RL, Rueegger, N.N., Grimson, M.J. and Taylor, B. D., (2015). *Specific nest box designs can improve habitat restoration for cavity-dependent arboreal mammals*. *Restoration Ecology*, 23(4), pp.482-490.
- Goldingay, RL, Thomas, K, and Shanty, D (2018). *Outcomes of decades long installation of nest boxes for arboreal mammals in southern Australia*. *Ecological Management & Restoration*, 19, p.204-211.
- Goldingay, RL. and Stevens, JR., (2009). *Use of artificial tree hollows by Australian birds and bats*. *Wildlife Research*, 36, p.81-97.
- Goldingay, RL. and Thomas, K.J., (2021). *Tolerance to high temperature by arboreal mammals using nest boxes in southern Australia*. *Journal of Thermal Biology*, 98, p.102899.
- Goldingay, RL., (2019a). *Nest box review and evaluation of nest box projects conducted for New South Wales Roads and Maritime Services* (unpublished).
- Goldingay, RL., (2019b). *Does temperature variation influence nest box use by the eastern pygmy-possum?*. *Australian Mammalogy*, 42(1), p.77-84.
- Goldingay, RL., Rohweder, D. and Taylor, BD., (2020a). *Nest box contentions: Are nest boxes used by the species they target?* *Ecological Management and Restoration*, 21(2), p.115-122.
- Griffiths, S.R., Semmens, K., Watson, S.J. and Jones, C.S., (2020). *Installing chainsaw-carved hollows in medium-sized live trees increases rates of visitation by hollow-dependent fauna*. *Restoration Ecology*, 28(5), p.1225-1236.
- Griffiths, ST., Lentini, PE., Semmens, K., Watson, SJ., Lumsden, LF. and Robert, KA., (2018). *Chainsaw-carved cavities better mimic the thermal properties of natural tree hollows than nest boxes and log hollows*, *Forests*, 9(5), p.235.
- Hofman, M., Gracanin, A. and Mikac, K.M., (2022). *Greater glider (Petauroides volans) den tree and hollow characteristics*. *Australian Mammalogy*, 45(2), pp.127-137.
- Honey, R., McLean, C.M., Murray, B.R., Callan, M.N., Webb, J.K. and Cooper, P., (2021). *Choice of monitoring method can influence estimates of usage of artificial hollows by vertebrate fauna*. *Australian Journal of Zoology*.
- Landcom (2004) 'Blue Book' Managing urban stormwater Vol 1.
- Lindenmayer, D.B., Crane, M., Evans, M.C., Maron, M., Gibbons, P., Bekessy, S., and Blanchard, W., (2017). *The anatomy of a failed offset*. *Biological Conservation* 210, p.286-292.
- Local Land Services Regional Strategic Weed Management Plan website
- Macak, PV., (2020). *Nest boxes for wildlife in Victoria: An overview of nest box distribution and use* [online]. *The Victorian Naturalist*, 137(1), p.4-14.

- McComb, L.B., Lentini, P.E., Harley, D.K.P., Lumsden, L.F., Eyre, A.C. and Briscoe, N.J., (2021). *Climate and behaviour influence thermal suitability of artificial hollows for a critically endangered mammal*. Animal Conservation.
- McNabb, E and Greenwood, J., (2011). *A Powerful Owl Disperses into Town and Uses an Artificial Nest-box*. Australian Field Ornithology 28(2), p.65-75.
- National Parks and Wildlife Service (1999). Threatened species information: [Bushrock removal factsheet](#)
- NSW Environment Protection Authority (2021). [NSW State of the Environment 2021 Tabled Report](#).
- NSW Health (Updated 15 January 2008) [Rabies and bat lyssavirus infection: Infectious disease fact sheet](#) NSW Health
- NSW Health (Updated 19 December 2007) [Leptospirosis: Infectious disease fact sheet](#) NSW Health.
- NSW Threatened Species Scientific Committee (2007). [Loss of hollow-bearing trees - key threatening process listing](#).
- Quin, B.R., Goldingay, R.L., Quin, D.G., Collins, E., Bartlett, N., Jerome, R., Murnane, T., Marsh, T. and Jessup, S., (2021). *Long-term monitoring of nest boxes and nest logs in a tree-hollow depleted box-ironbark forest in north-eastern Victoria*. Australian Journal of Zoology, 68(3), p.150-166.
- Roads and Maritime Service (2015) [Guideline for Batter Surface Stabilisation using vegetation](#).
- Roads and Maritime Services (2018) [Landscape design guideline: design guideline to improve the quality, safety and cost effectiveness of green infrastructure in road corridors](#) (Access from the TfNSW website)
- Roads and Maritime Services [Stockpile Site Management Guideline](#) (2015) (Access via the TfNSW SharePoint site)
- Rowland, J.A., Briscoe, N.J. and Handasyde, K.A., (2017). *Comparing the thermal suitability of nest-boxes and tree-hollows for the conservation-management of arboreal marsupials*. Biological Conservation, 209, p.341-348.
- Rueegger, N., (2017). *Artificial tree hollow creation for cavity-using wildlife – trialling an alternative method to that of nest boxes*. Forest Ecology and Management, 405, p 404-412
- Rueegger, N., Goldingay, R.L., Law, B. and Gonsalves, L., (2019). *Limited use of bat boxes in a rural landscape: implications for offsetting the clearing of hollow-bearing trees*. Restoration Ecology, 27(4), pp.901-911.
- Saunders, D.A., Dawson, R., Mawson, P.R. and Cunningham, R.B., (2020). *Artificial hollows provide an effective short-term solution to the loss of natural nesting hollows for Carnaby's Cockatoo *Calyptorhynchus latirostris**. Biological Conservation, 245, p.108556.
- Stojanovic, D., Cook, H.C., Sato, C., Alves, F., Harris, G., McKernan, A., Rayner, L., Webb, M.H., Sutherland, W.J. and Heinsohn, R., (2019). *Pre-emptive action as a measure for conserving nomadic species*. The Journal of Wildlife Management, 83(1), p.64-71.
- Strain, C., Jones, C.S., Griffiths, S.R. and Clarke, R.H., (2021). *Spout hollow nest boxes provide a drier and less stable microclimate than natural hollows*. Conservation Science and Practice, p.e416.
- Terry, W., Goldingay, R.L. and van der Ree, R., (2021). *Can chainsaw carved hollows provide an effective solution to the loss of natural tree cavities for arboreal mammals?* Forest Ecology and Management, 490, p.119122.

Thomson, C.N., (2006). *A trial of the use of artificial nest-boxes for the Masked Owl Tyto novaehollandiae near Newcastle, New South Wales*. Australian Field Ornithology, 23(4), p.192-197. Biodiversity Conservation Trust (2020) Guideline for Artificial Hollows.

Velasco, S., French, K., Law, B. and Threlfall, C.G., (2023). Bat boxes in urban bushland are associated with inflated activity of an urban generalist bat, but not an altered community. Austral Ecology.

Related Transport for NSW documents and resources

RTA (2005) [Guideline for the Management of Acid Sulfate Materials](#).

Sydney Trains [EMS-06-FM-0227 Threatened Species Monitoring Form.DOCX](#)

Sydney Trains [EMS-06-GD-0067 Vegetation Management in the Corridor.pdf](#)

Sydney Trains [EMS-06-GD-0068 Sowing Guide for Disturbed Site Stabilisation.pdf](#)

Sydney Trains [EMS-06-GD-0070 Identification of Common Rail Corridor Weeds.pdf](#)

Sydney Trains [EMS-06-OR-1006 Biodiversity Organisational Procedure.pdf](#)

Sydney Trains [EMS-06-TP-0064 Bush Regeneration Technical Specification Template.DOCX](#)

Sydney Trains [EMS-06-TP-0065 Weed Control Technical Specification Template.DOCX](#)

Sydney Trains [EMS-06-TP-0152 Vegetation Management Scope of Work Template.DOCX](#)

Sydney Trains [EMS-06-WI-0150 Environmentally Sensitive Site Signage Work Instruction.pdf](#)

Sydney Trains [EMS-06-WI-0178 Fauna Impact Mitigation When Clearing Vegetation.pdf](#)

Transport for NSW Standard requirements (Works Contract) DMS-FT-425 for rail (Access via transport.nsw.gov.au/projects/project-delivery-requirements).

[Transport Biodiversity Policy](#) (Access via the TfNSW Environment and Sustainability Source SharePoint site or the [TfNSW Biodiversity webpage](#)).

Transport for NSW (2022) [Schedule of Classified Roads and Unclassified Regional Roads V13](#).

Transport for NSW '[Biodiversity Guidelines on a page](#)' (Access from the TfNSW Environment and Sustainability Source SharePoint site).

Transport for NSW [Biodiversity Assessment Guidelines](#) (Access via the TfNSW Environment and Sustainability Source SharePoint site).

Transport for NSW [EMF-BP-FS-0006 Approved Pesticides Fact Sheet](#) (Access via the TfNSW Environment and Sustainability Source SharePoint site).

Transport for NSW [EMF-BP-FS-0006 Approved Pesticides Fact Sheet](#) (Access via the TfNSW Environment and Sustainability Source SharePoint site).

Transport for NSW Maintenance & Delivery Online Management System, Environmental fact sheet – [EFS- 33 Vehicle Hygiene](#).

Transport for NSW [Microbat Management Guidelines: A guide for undertaking works in culverts, bridges and other structures](#) (Access via the TfNSW Environment and Sustainability Source SharePoint site or the [TfNSW Biodiversity webpage](#)).

Transport for NSW QA Specification for roads [G40 Clearing and Grubbing](#) (Access via the TfNSW intranet 'CPS documents directory' page).

Transport for NSW QA Specification [G36 Environment Protection](#) for road (Access via the TfNSW intranet 'CPS documents directory' page).

Transport for NSW QA Specification [R178 Vegetation](#) and [R179 Landscape Planting](#) (Access via the TfNSW intranet 'Roadworks specifications – TAD' page).

Transport for NSW QA Specifications [G38 Soil and Water Management](#) for road (Access via the TfNSW intranet 'CPS documents directory' page).

Transport for NSW [Tree and Hollow Replacement Guidelines](#) EMF-BD-GD-0129 (Access from the TfNSW Environment and Sustainability Source SharePoint site).

External access to Transport for NSW documentation can be requested by emailing environmentandsustainability@transport.nsw.gov.au.



© Transport for New South Wales

Users are welcome to copy, reproduce and distribute the information contained in this report for non-commercial purposes only, provided acknowledgement is given to Transport for NSW as the source.